



CENTERFIRE RIFLE CARTRIDGES



AGENDA



1. THE STORY OF SUCCESS
2. ALWAYS ON THE SAFE SIDE
3. INSIGHT INTO PRODUCTION
4. RWS SPECIAL BULLETS AND THEIR ADVANTAGES
5. SPECIAL PRODUCTS AND SPECIAL SERIES
6. OUTLOOK AND SUMMARY



THE STORY OF SUCCESS

Why so many hunters trust in RWS ...





MORE THAN A CENTURY OF GERMAN PRODUCTION.

Short historical abstract

4



MADE IN GERMANY

Rheinisch
Westfälische
Sprengstoff-
fabriken

(RWS)

1886
founded
in Troisdorf

Dynamit
Nobel

1931-2002
Troisdorf

RUAG
Ammotec

since 2003
Fürth



RWS – THE AMMUNITION COUNTS.

Convincing facts

- RWS is the European leader in hunting and sports ammunition.
- RWS is rated as the most reliable, most competent and most innovative brand*
- RWS stands for accuracy, hunting with ethic principles, less wasted meat and no or short flight distances*
- RWS is distributed in more than 50 countries



*Sources: forum! Marktforschung Analyse 2007, GfK Marktforschung Analyse 2004



THE OPINIONS OF FAMOUS HUNTERS CONFIRM: RWS ammunition makes for a perfect hunt.

6

"RWS special bullets [...] perform reliably and kill in a quick and humane manner. And, if a shot is not as perfectly placed as I would wish, then my experience is that their special bullets make all the difference. In general, the game drops after only a few meters..."

Hermann Wolff
(General Manager of the Federation of German Professional Hunters)



„ [...] On the hunt I place my trust entirely in my Mauser M 03 in combination with the UNI Classic! This is the combination of proven weapon and projectile design that give me reliability and adequate reserves for a humane hunt of even heavy game around the world!

Thorsten Mann (General Manager of Mauser Jagdwaffen GmbH)

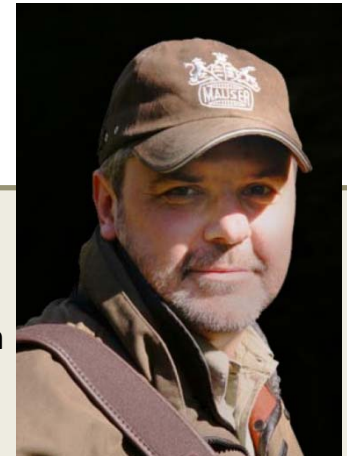



ALWAYS ON THE SAFE SIDE

The subtle difference





WHY IS RWS SO SUCCESSFUL?

Because of the consistent quality loaded into each and every cartridge.

8





REASSURING,
when you know you have a cartridge you can count on.

9





RWS MEANS RELIABILITY.

Built into every shot.

- Over 100 separate steps are required to make one complete cartridge
- Strict quality controls are performed at each step
- Each lot is test fired at least 7 times before it is approved for release
- 2400 commonly available firearms are available for test purposes



RWS lets you focus on the chase, not the case!

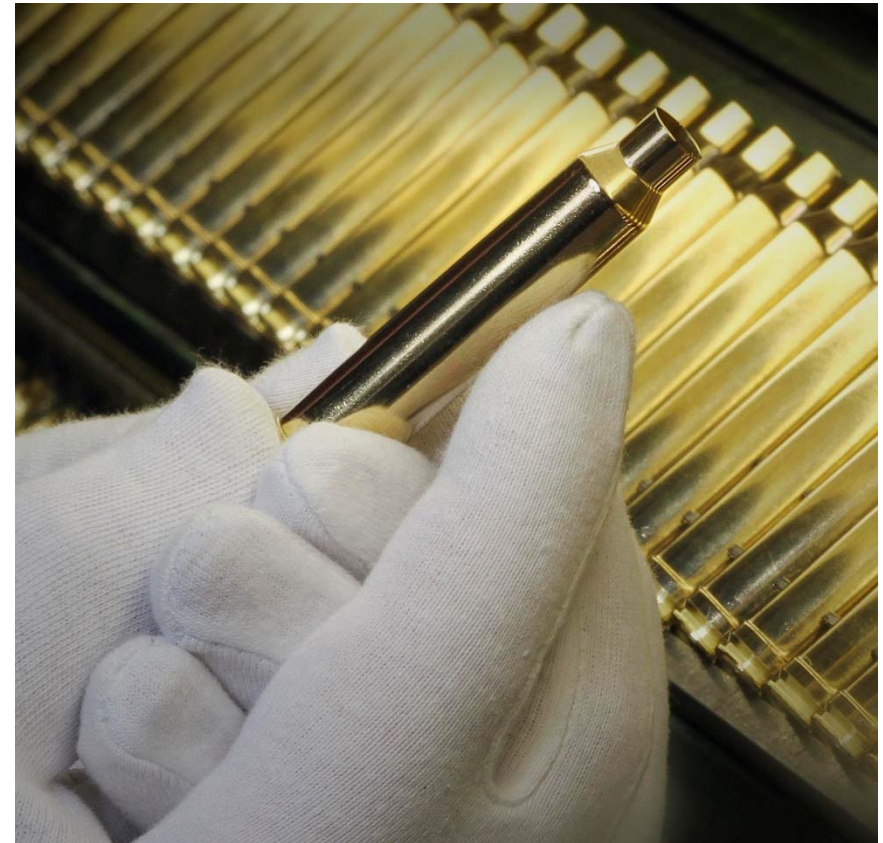



ACCURATE,
even at long range.

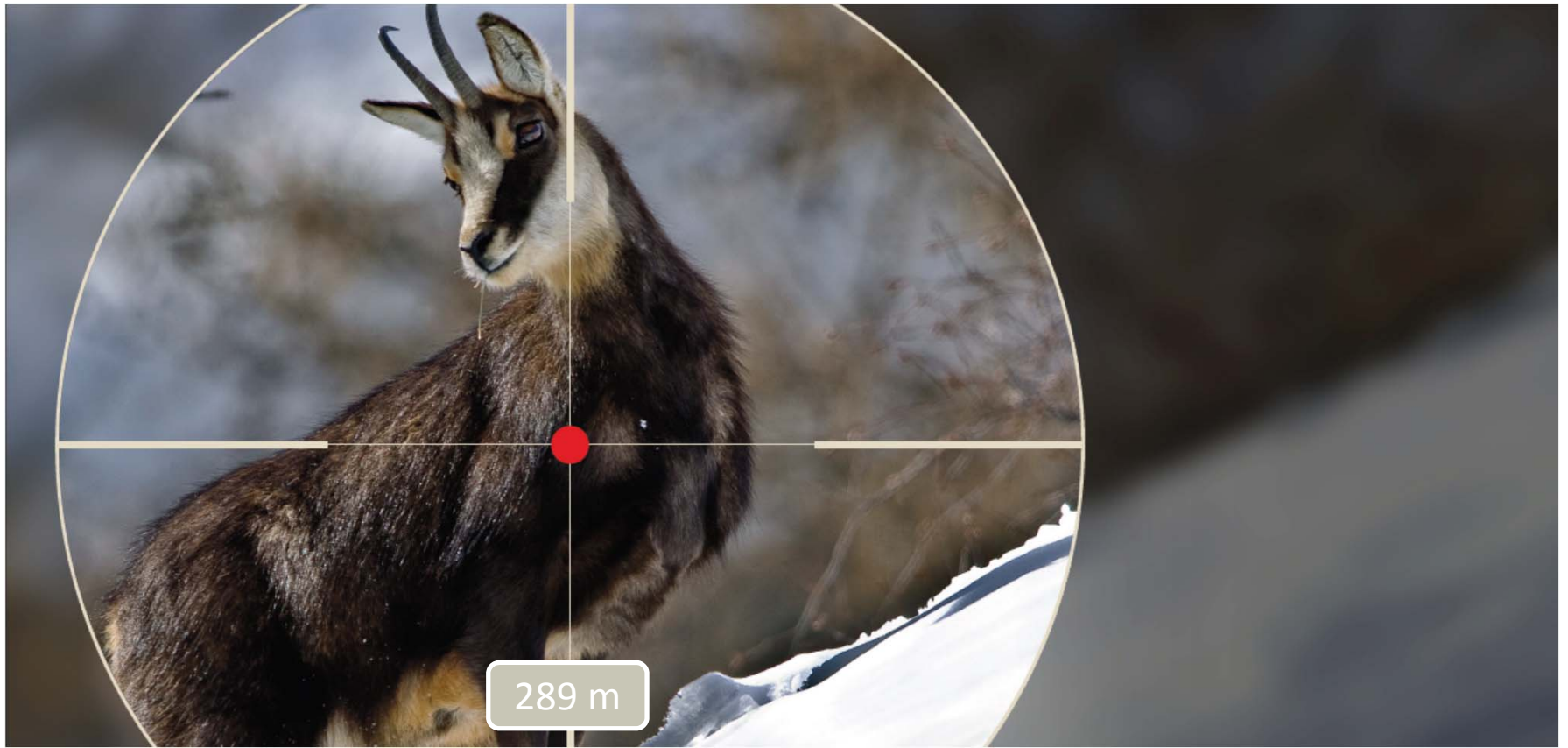



ACCURATE CARTRIDGES

The result of precise workmanship

- Every component is tested at our own firing ranges
- There are 35 company-owned firing ranges including a 500 m indoor lane
- Actual trajectories are measured with radar
- Over 1000 special test barrels are available to measure working pressure and accuracy
- Constant high quality thanks to bullets, cases and primers made in our own facilities



RWS lets you focus on the chase, not the case!

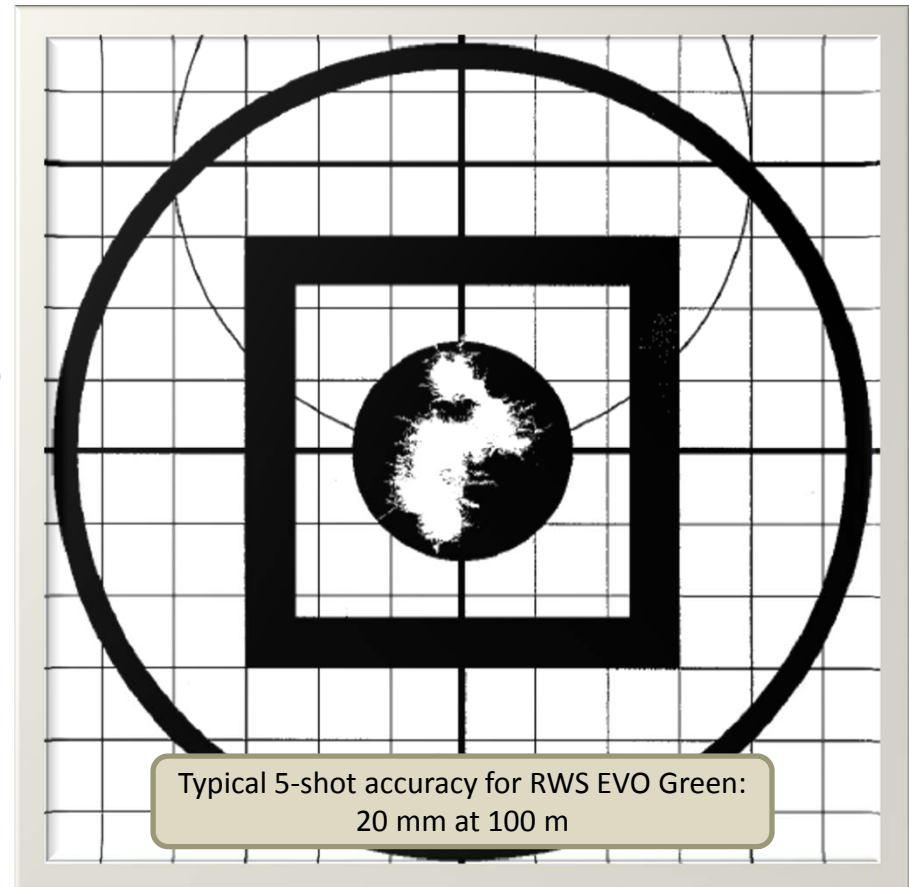



IDEAL,
if the game drops in its tracks.

13



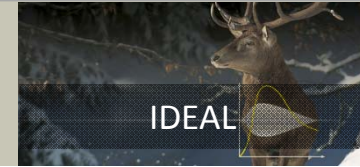

THE RWS TRIPLE-EFFECT PRINCIPLE ASSURES CERTAIN SUCCESS .
Even under less than ideal conditions.

14

Initial shock

- Prompt killing effect makes for short flight distances, resulting in less time spent searching for game

Penetration shock

High impact with great depth of penetration, particularly on large game and with angling shots

Exit wound

For a certain blood trail in case a search is necessary



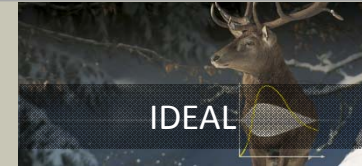

PROVEN EFFECTIVE IN THE LAB AND IN THE FIELD.

Developed by specialists, tested by hunters.

- Approximately 2,500 gelatin blocks are used in firing tests each year
- X-ray images have been used for the evaluation of proof load firings since 1950
- Projectile development based on more than 250,000 test firing reports
- RWS' own hunting preserve for analysis of effectiveness under field conditions



RWS lets you focus on the chase, not the case!



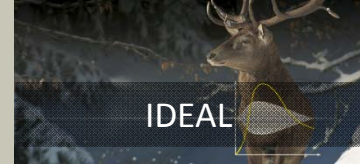

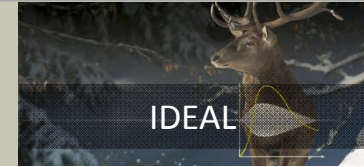

WITH RWS, EFFECTIVENESS IS NO COINCIDENCE.
Specially tailored to fit every purpose.

GELATIN BLOCK ...

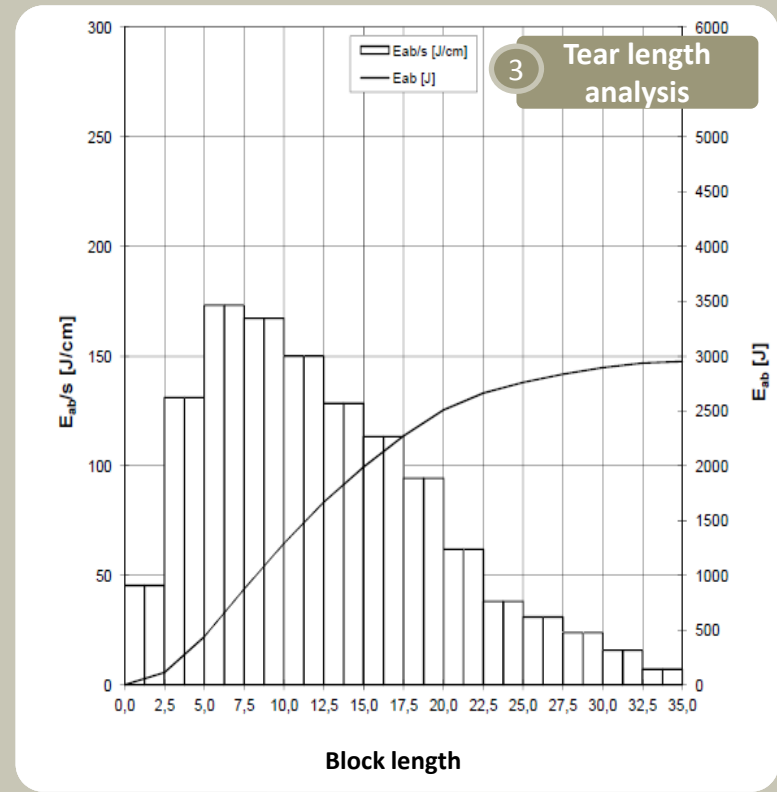



GOOD,
when you have a cartridge that you can count on.

18





RWS CREATES REDUNDANT SAFETY

So you have nothing to worry about.

19

- 4 laboratory tests before acceptance of raw materials
- 8 quality checks during production of RWS cases
- Up to 26 manual checks during the production of each centrefire cartridge
- Daily quality assurance by a qualified staff of 35
- Cartridges designed to be used in extreme temperatures (-30° C to +60° C)



RWS lets you focus on the chase, not the case!





INSIGHTS INTO PRODUCTION

centrefire rifle cartridges:
components, function and manufacturing process





CONSTRUCTION OF A CENTREFIRE RIFLE CARTRIDGE

Components and their functions

21

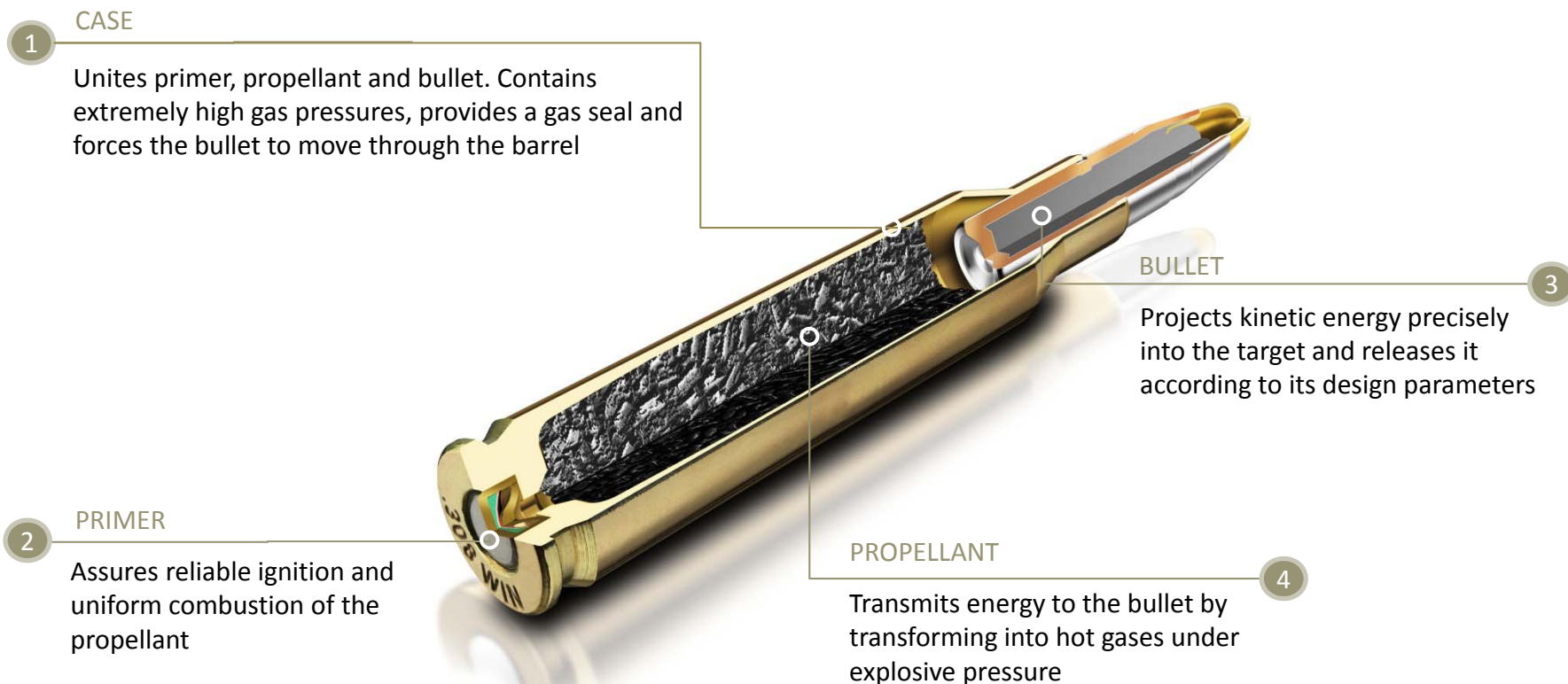



THE RWS CASE

Composition and functions

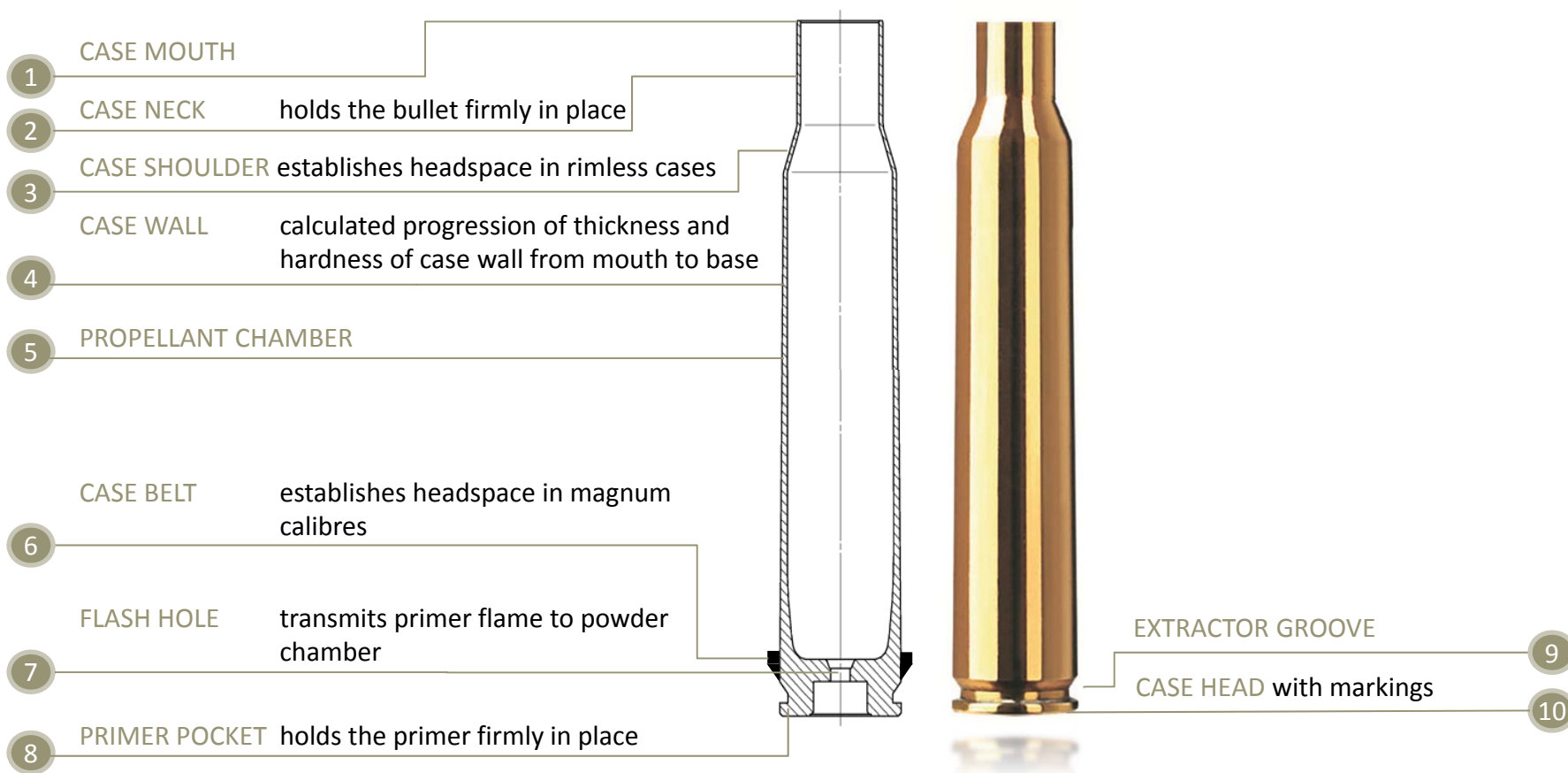



RWS CASES

Manufacturing process

23

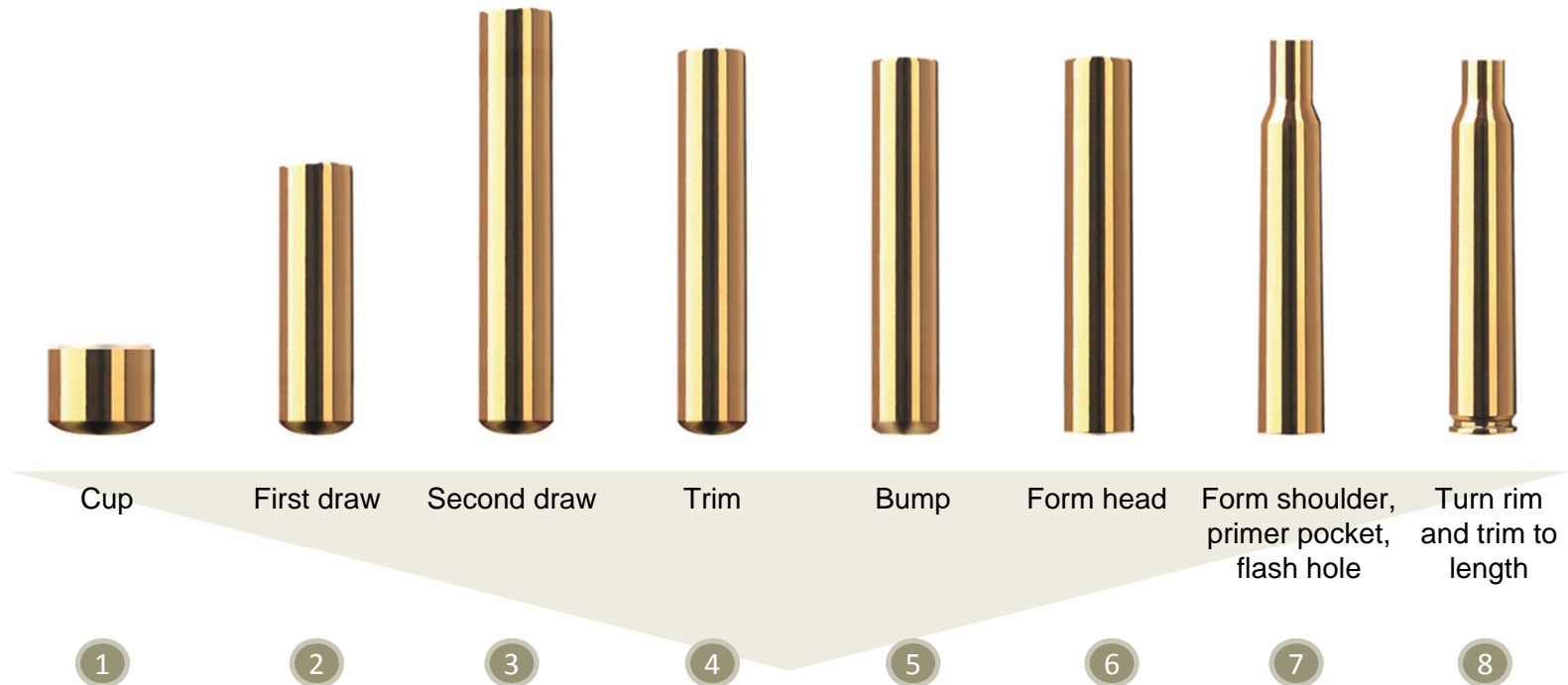

A quality cartridge case is the shooter's life insurance. It must withstand extremely high gas pressures up to 7000 bar!
Therefore, RWS cases must pass the most demanding quality tests in the industry.



CASE SHAPES

24



Rimmed case

Characterised by the “R”
in the calibre name, e.g.
.30 R Blaser
7x65 R
9.3x74 R



Rimless case

The most common case configuration,
e.g. .30-06 Springfield
7x64
9.3x62



Belted case

e.g. 7 mm Rem. Mag.
.300 Win. Mag.
.375 H&H Mag.



BULLET

Production steps using the RWS UNI CLASSIC as an example

25



cup

1



draw and trim

2



form boattail and
insert rear core

3



insert front core, pre-
compress, and press to
final shape

4



apply cannelures
and size to
diameter

5



PROPELLANT POWDER

The process of combustion

26



Gas volume, gas pressure and barrel length determine the initial velocity of the bullet.



COMPOSITION OF AN RWS ANVIL PRIMER

Reliable ignition

27

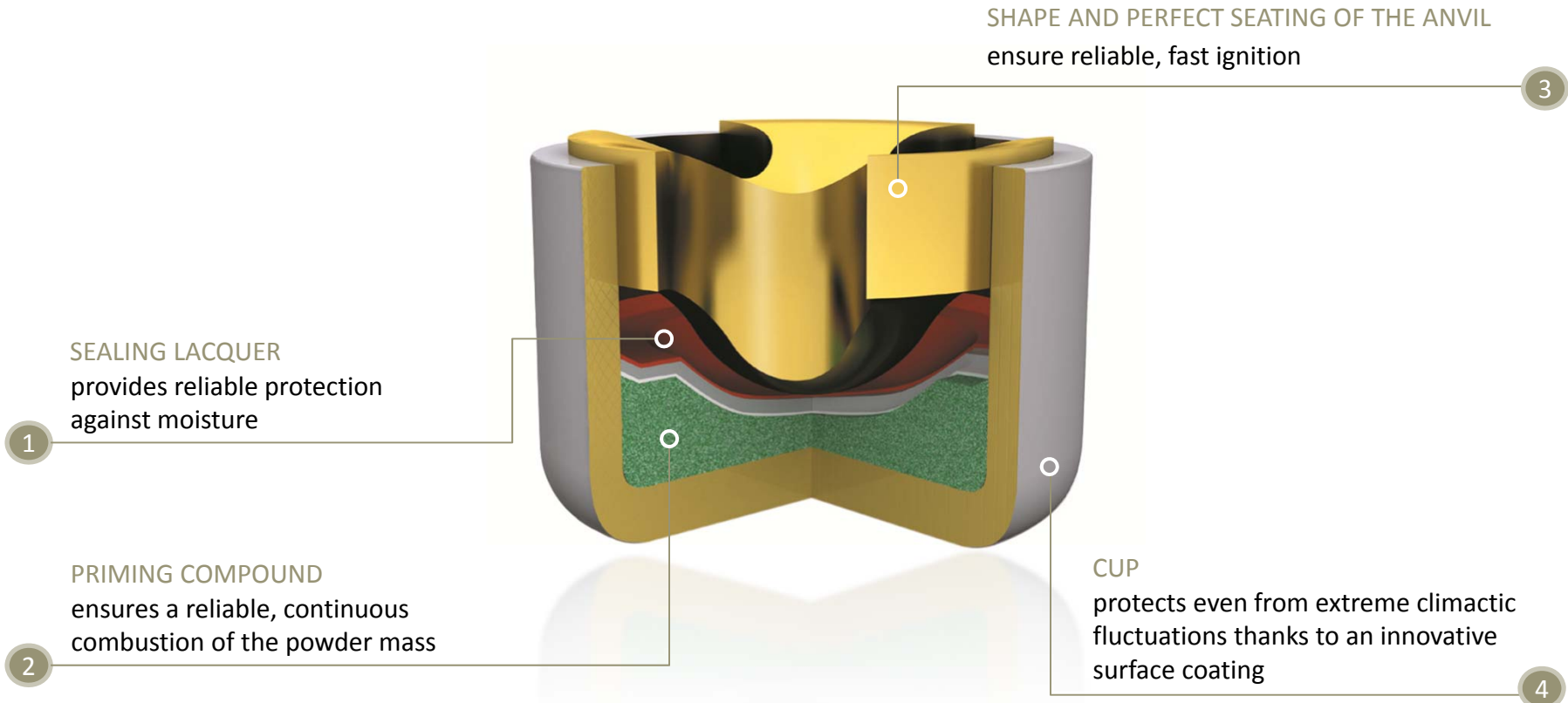



COMPONENT ASSEMBLY

Accuracy through perfection

28

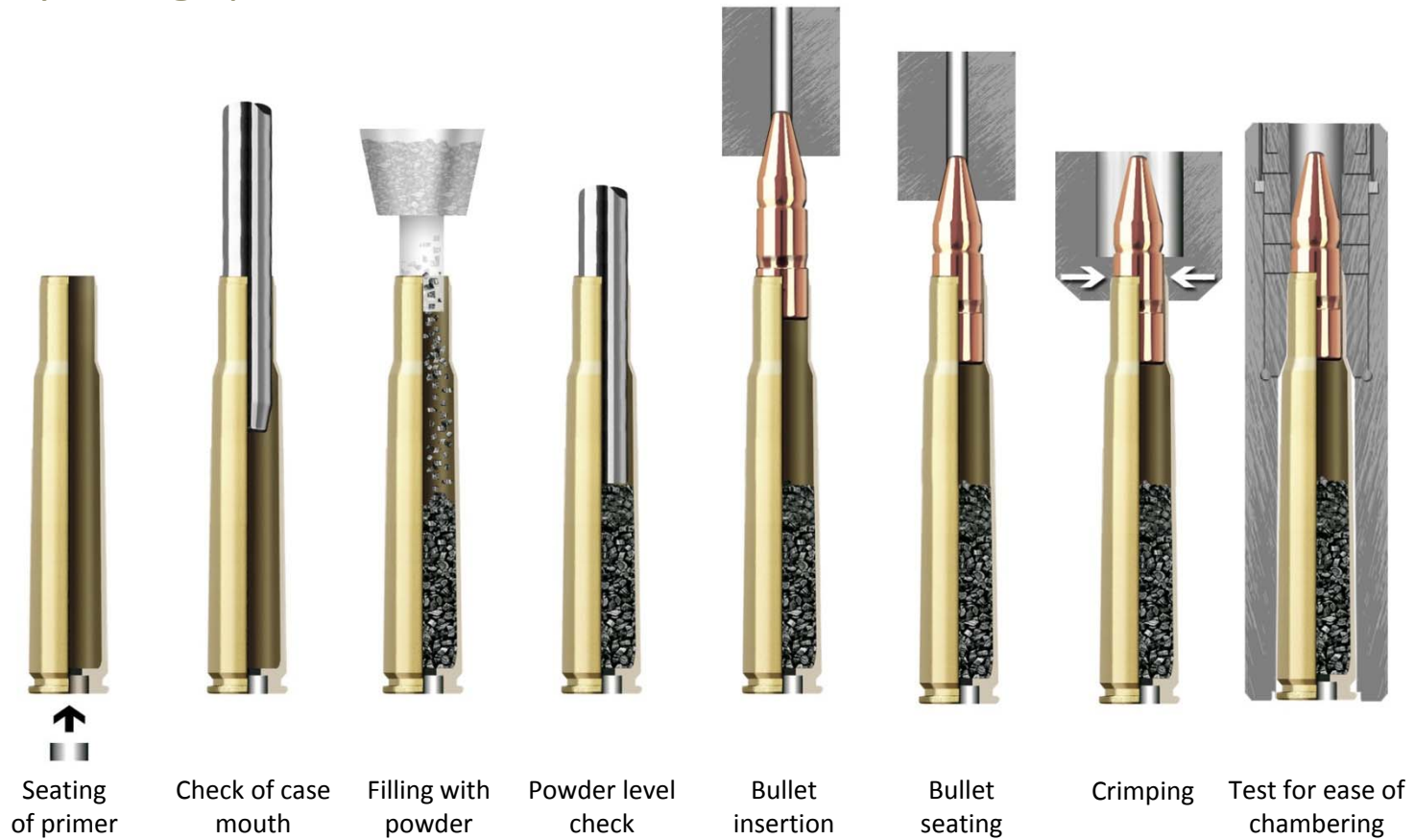



COMPONENT ASSEMBLY

Accuracy through perfection

- All components are matched to each other: Every case gets a primer exactly suited to its purpose
- Propellant is added in the smallest possible increments
- The bullet is crimped into the case for a secure fit
- The cartridge is tested for ease of chambering





RWS SPECIAL BULLETS AND THEIR ADVANTAGES





BULLET TYPES

and how they function

31

DEFORMATION BULLET WITH BONDED CORE

- Mushrooms without fragmentation
- Effect is mainly based on cross-sectional expansion with consistent weight retention
- High probability of an exit wound



FRAGMENTATION BULLET

- Disintegrates except for the rear section, which is designed to retain a defined shape and mass
- Massive organic destruction caused by fragmentation with penetration



FMJ (full metal jacket) BULLET

- Stable in both form and mass
- Deep penetration





CUSTOM-MADE IMPACT

A comparison of two classic bullets

32



FULL METAL JACKET BULLET



SOFT POINT BULLET



PRINCIPLES OF DEVELOPMENT for RWS Special Bullets

33





EVOLUTION

For convincing penetration

34

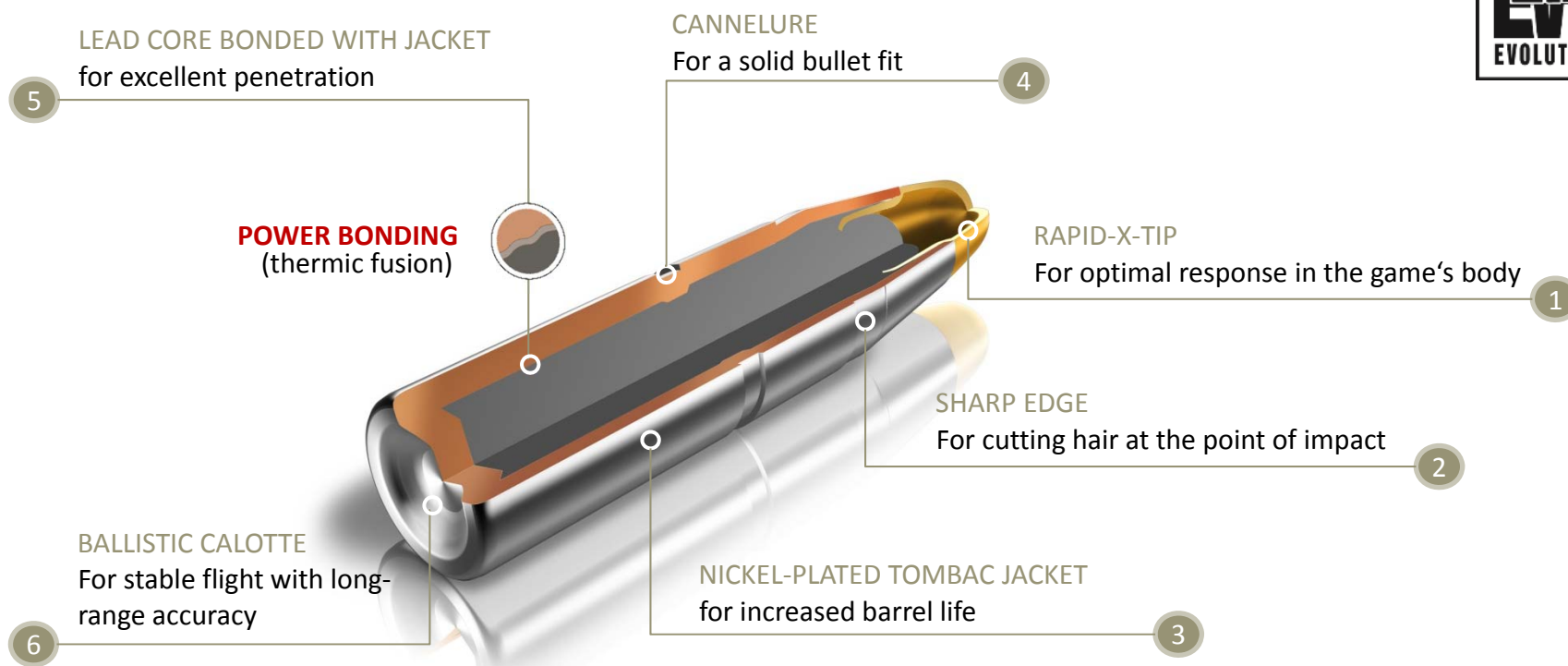



EVOLUTION

For convincing penetration

- Fast deformation
- Suitable for all shooting distances
- Convincing penetration
 - even when impacting bone
- Preserves the meat
- Protects the barrel from excessive wear
- Outstanding accuracy





EVOLUTION

For convincing penetration

36

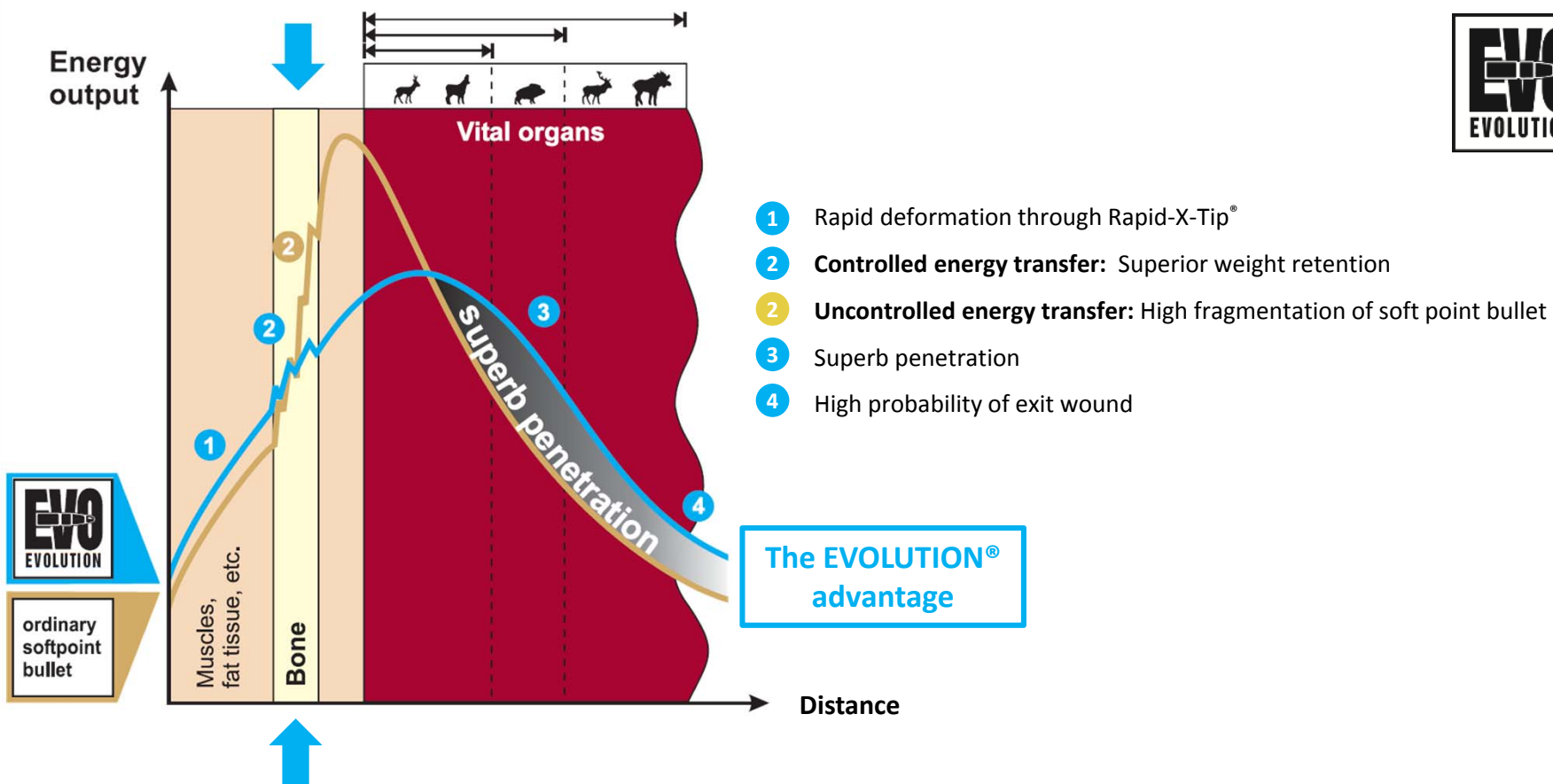



EVOLUTION

For convincing penetration

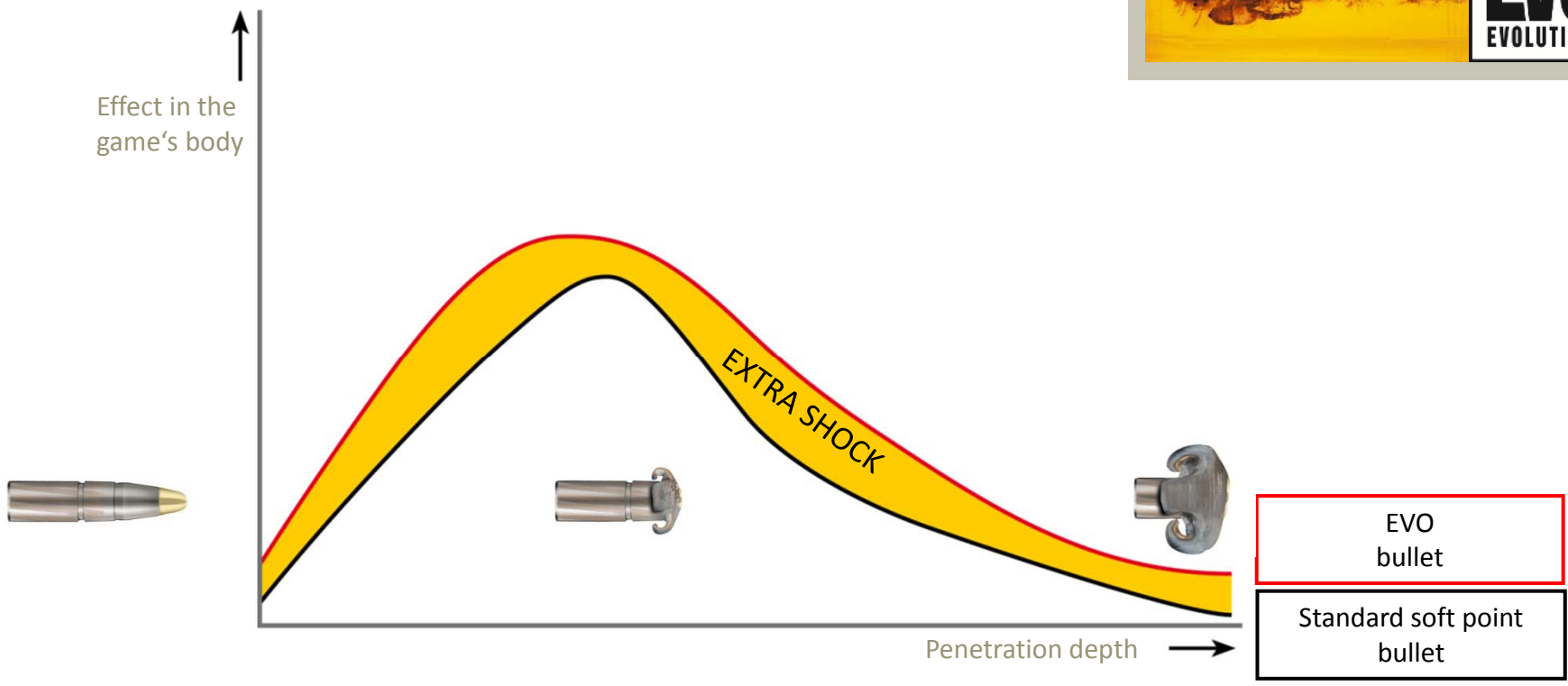
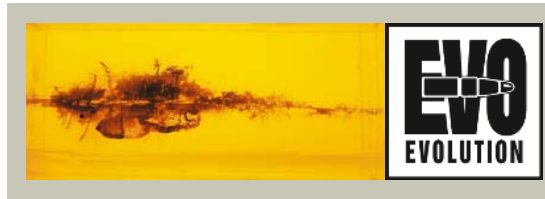



EVOLUTION GREEN

The intelligent alternative

38



FRONT CORE COMPOSED OF FOOD-SAFE TIN, WITH A RADIAL PRE-DETERMINED BREAK POINT

for reliable impact behaviour and high impact shock



1

STRONGER JACKET
for a reliable exit wound

7

SPEED TIP BULLET POINT
for maximum knock-down power and a flat trajectory

2

THINNER JACKET
for a fast reliable response

3

SHARP EDGE
for cutting hair at point of impact

4

STABLE AND IMPACT RESISTANT REAR
CORE OF HARD, FOOD-SAFE TIN
for extreme penetration

6

NICKEL-PLATED BULLET JACKET
for increased barrel life

5





EVOLUTION GREEN

The intelligent alternative

- Shorter flight distances thanks to impressive impact shock
- Outstanding ballistics and flat trajectory
- Impressive killing effect even at long range
- Reliable tracking signs





EVOLUTION GREEN

The intelligent alternative

40



Effect in the
game's body

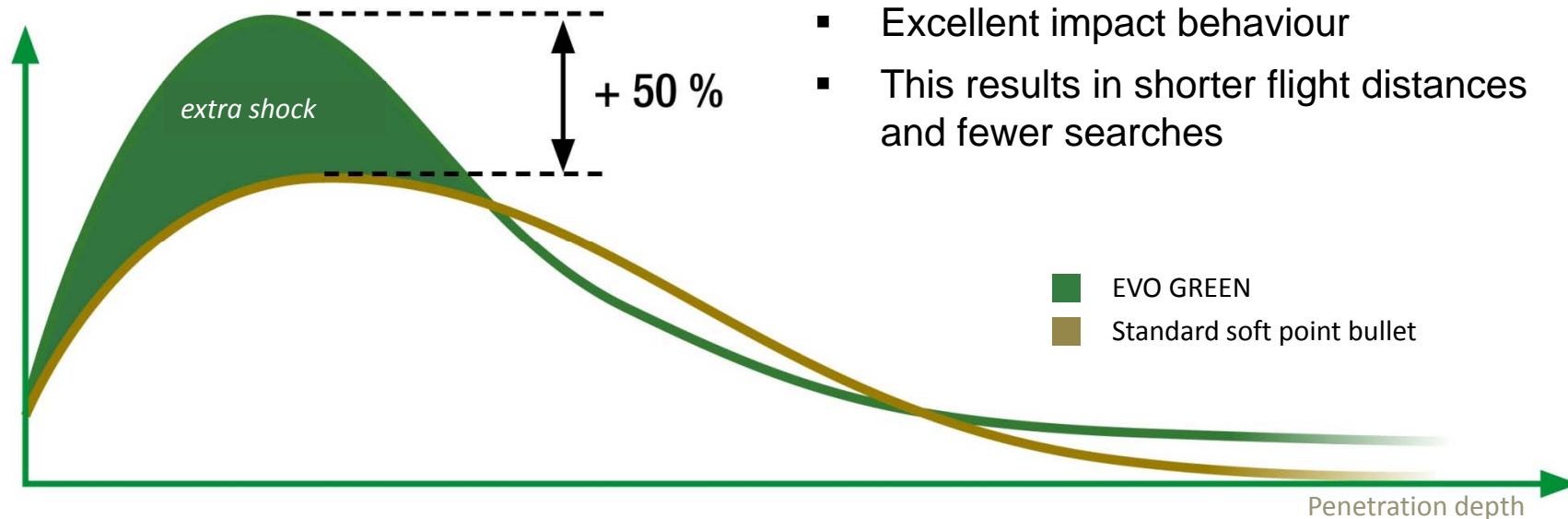

- Excellent impact behaviour
- This results in shorter flight distances and fewer searches



HIT (HIGH IMPACT TECHNOLOGY)

Convincing penetration – lead-free

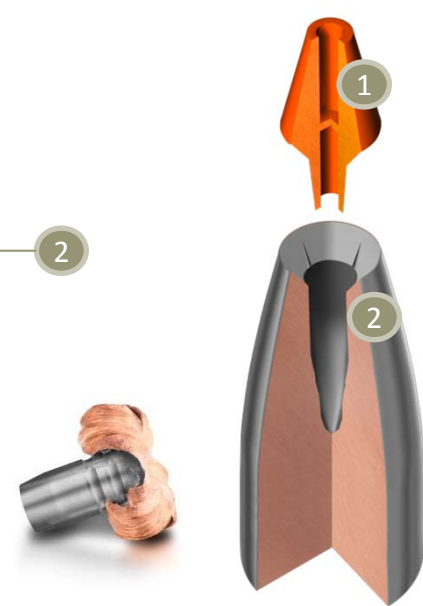
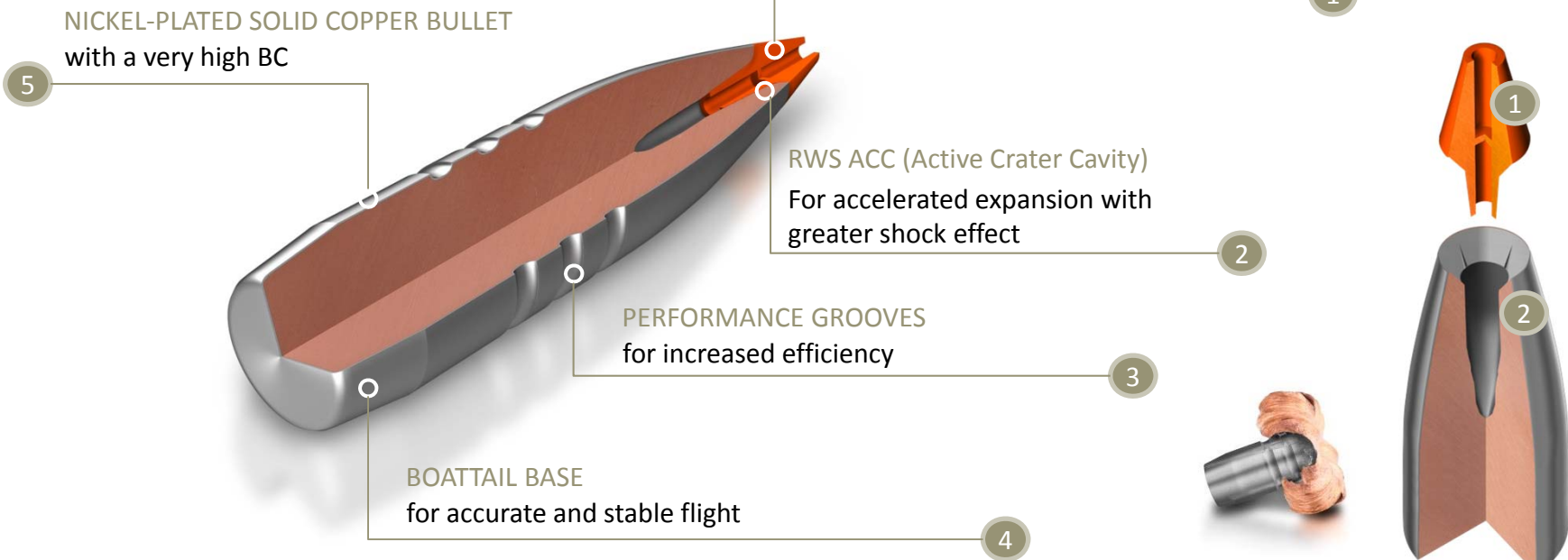



HIT (HIGH IMPACT TECHNOLOGY)

Convincing penetration – lead-free

- Powerful penetration, even through heavy bone
- Flat trajectory
- Great shock effect
- Minimal meat loss
- 100% lead-free, non-fragmenting bullet

Bleifreies Geschos
GREEN
Lead-free bullet

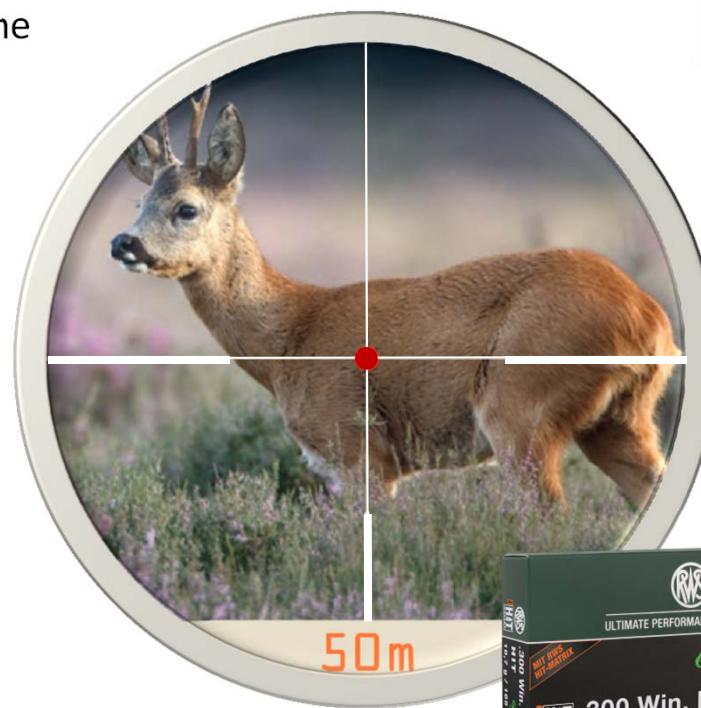



HIT (HIGH IMPACT TECHNOLOGY)

Quick and certain bullet expansion coupled with great shock-effect – even at longer ranges.

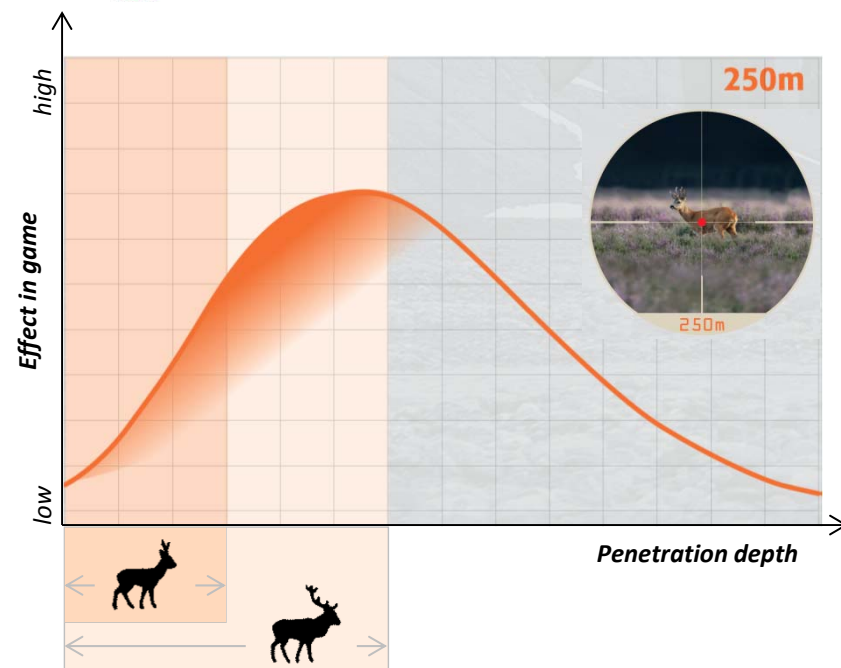
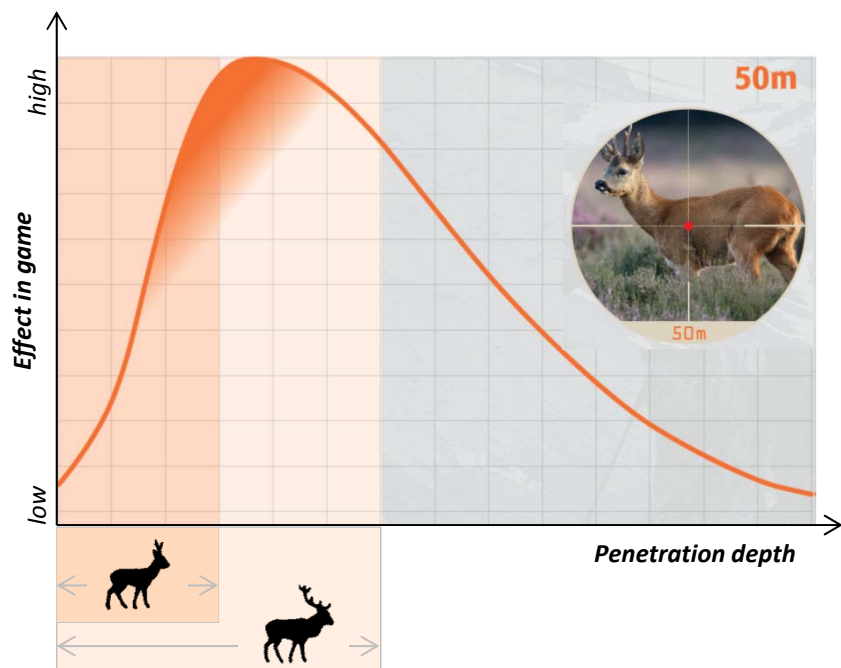



UNI CLASSIC

For heavy game

44

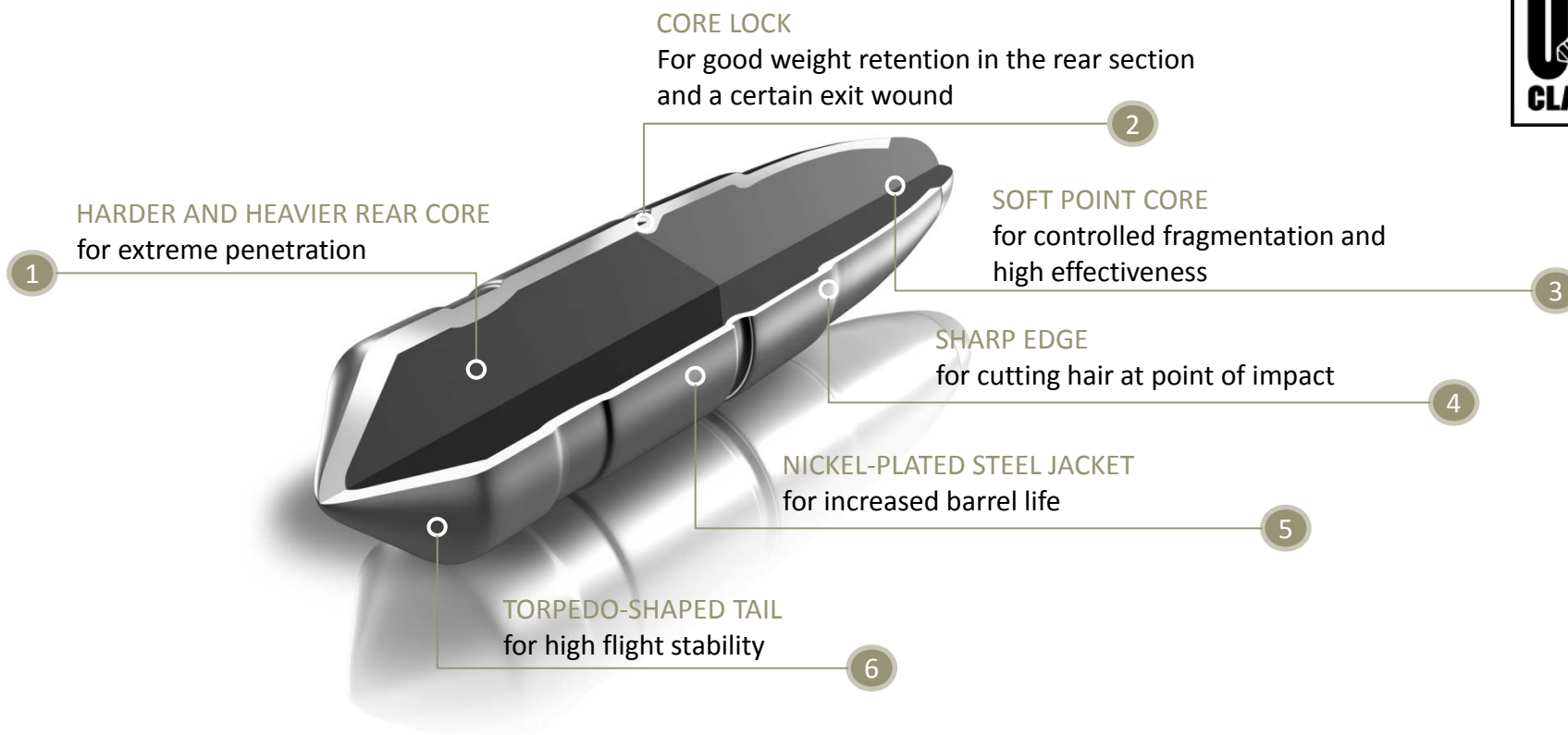



UNI CLASSIC

For heavy game

- UNIVERSAL for heavy game
- Front core fragments and ensures a fast energy transfer to the target
- Sharp edge makes a clearly visible entry wound with a clean cut
- Harder rear core shows limited deformation and reliably produces the desired exit wound
- Rear core lock limits jacket fragmentation
- Little damage to the meat





UNI CLASSIC

For heavy game

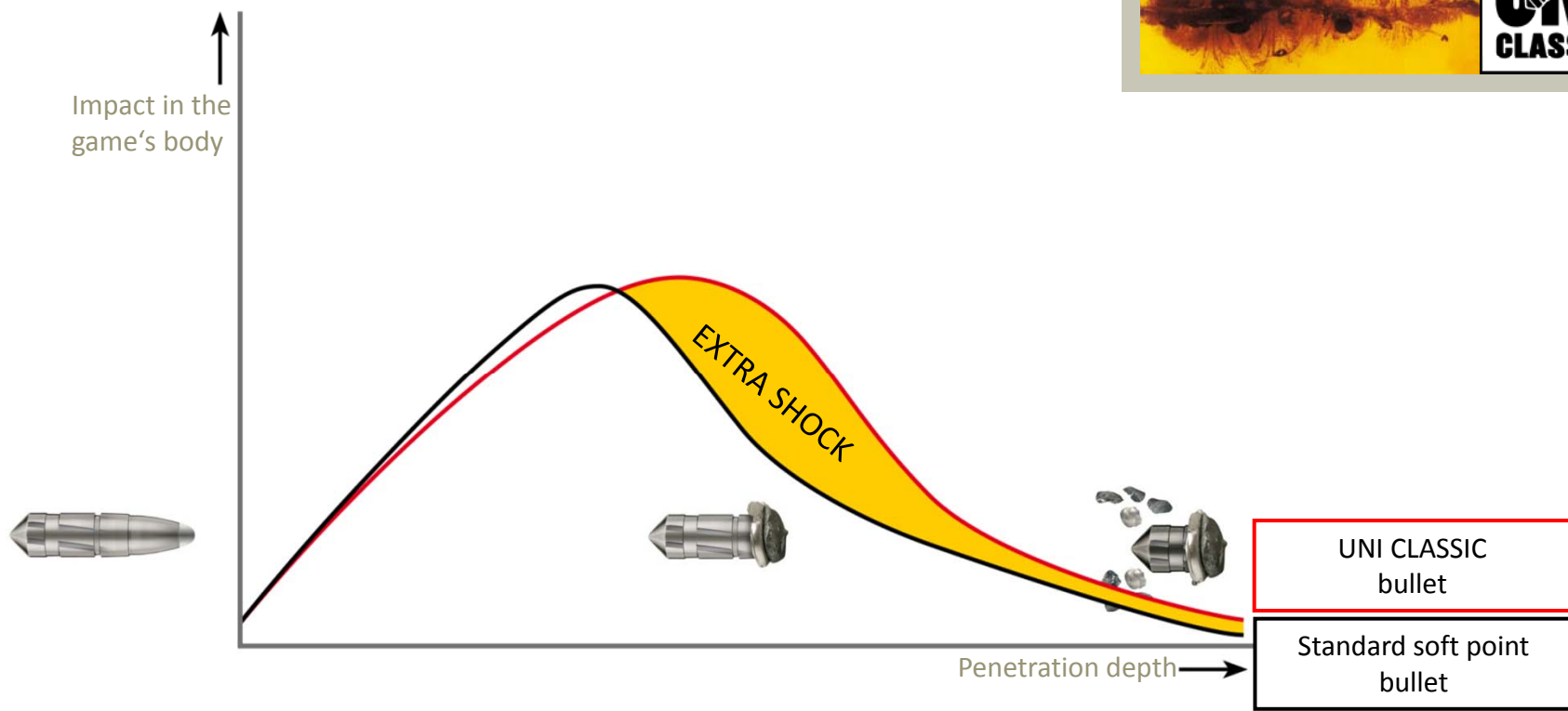
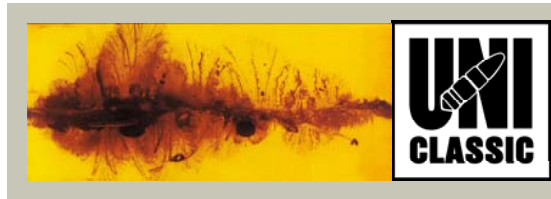



TWIN CORE DK

For a controlled impact shock

47

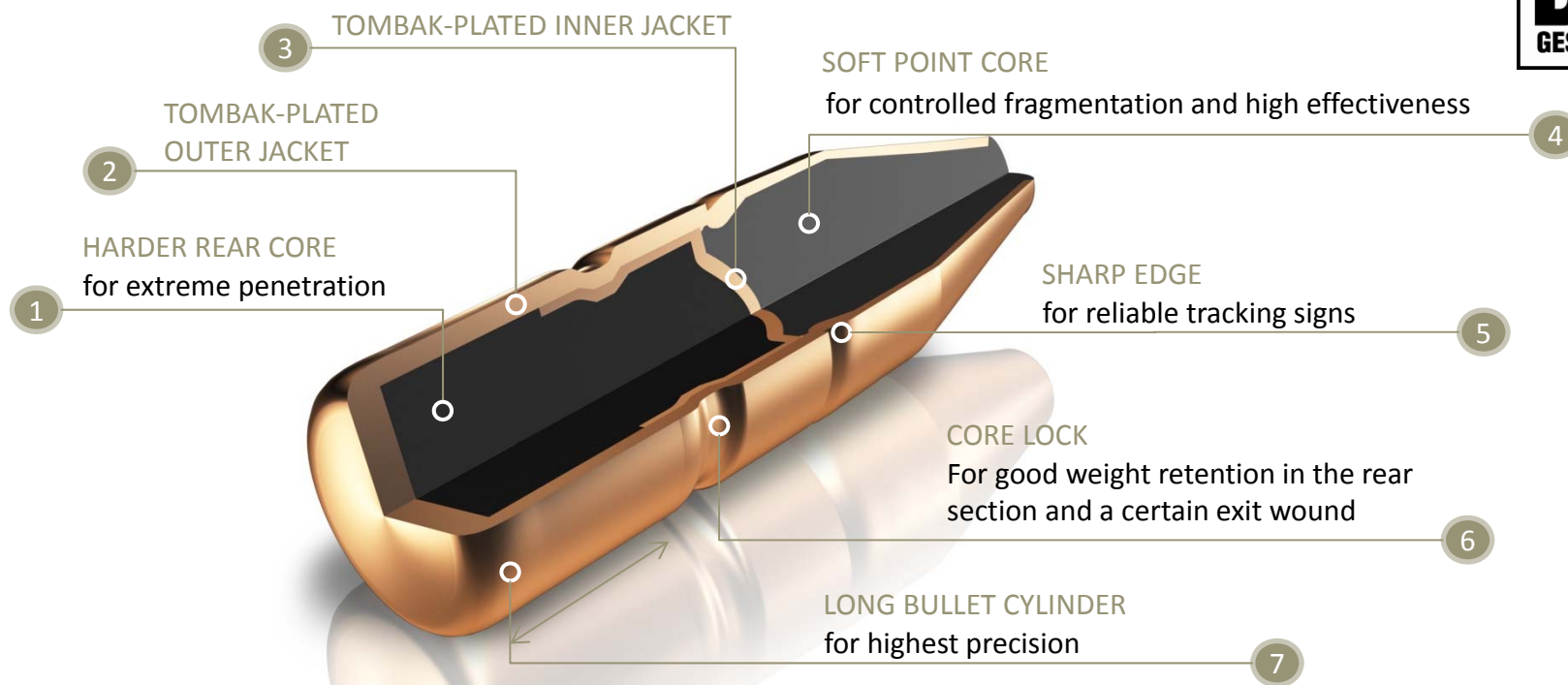



TWIN CORE DK

For a controlled impact shock

- Good, clear effect of the shot on the game
- Extremely short flight distance
- Sharp edge ensures a clean-cut exit wound
- Fast, controlled energy transfer produces high impact shock
- Reliable exit wound guarantees enough blood flow
- Little damage to the meat





TWIN CORE DK

For a controlled impact shock

49

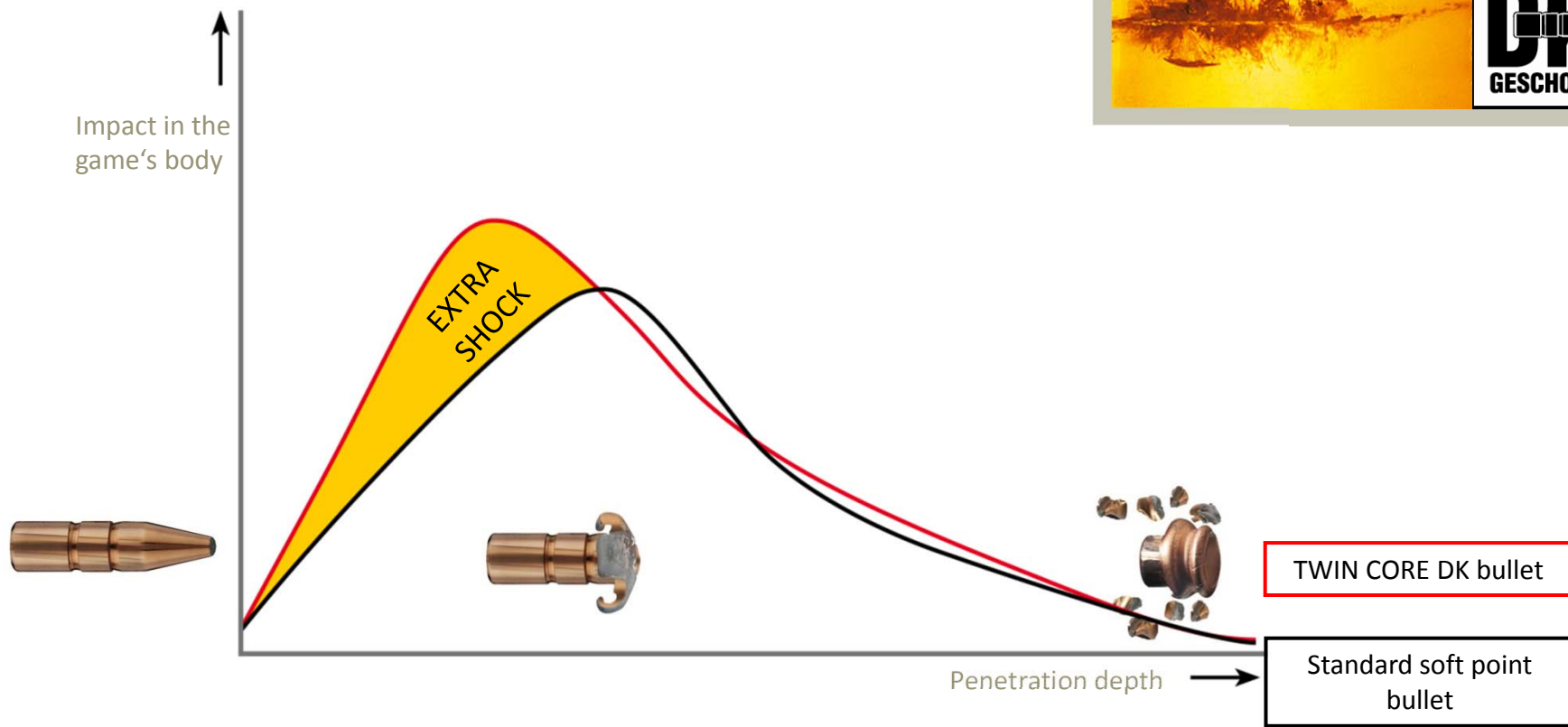
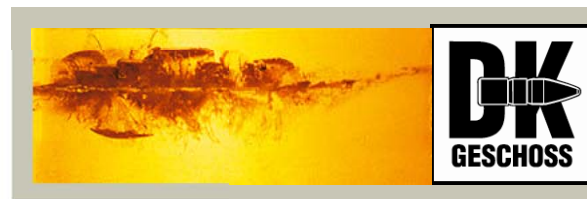



H-MANTEL HM

For maximum effect

50

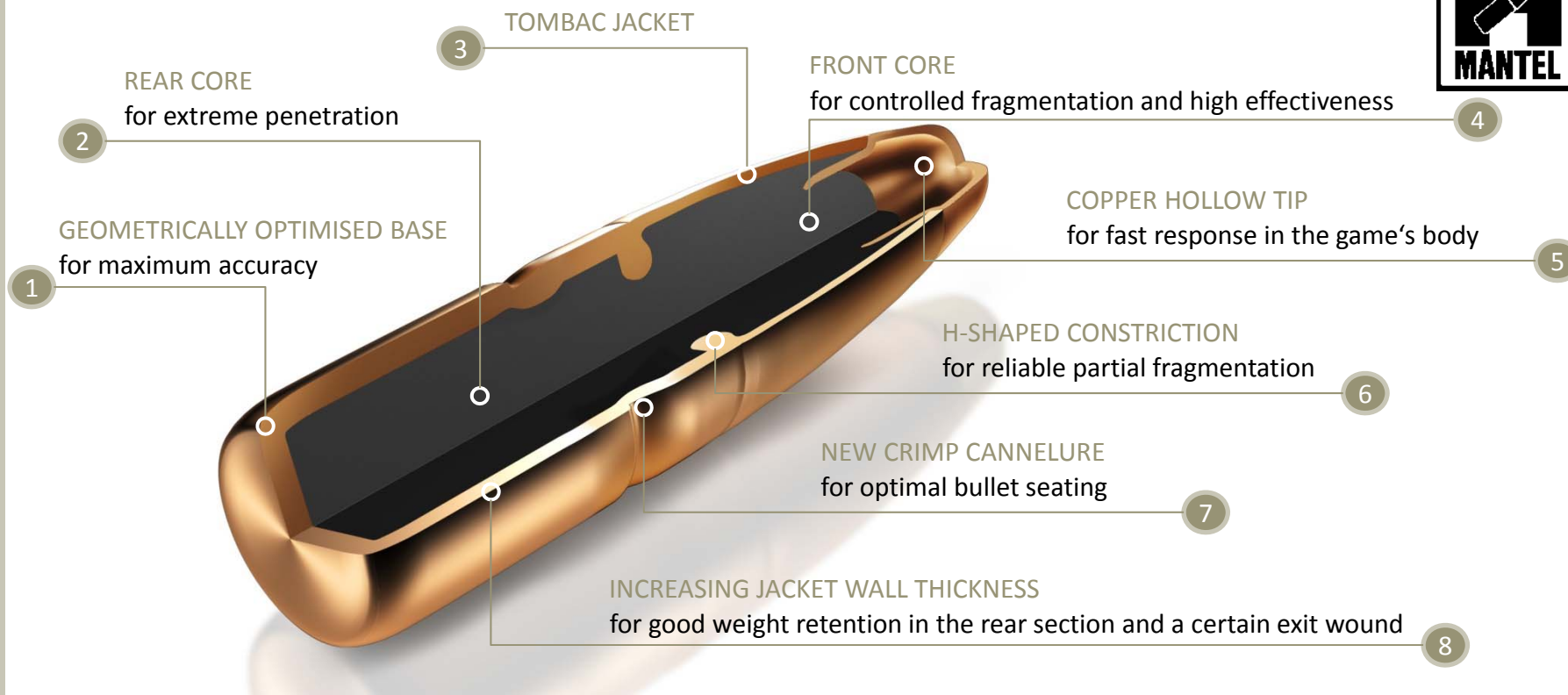



H-MANTEL HM

For maximum effect

- Bullet is highly effective
- H-shaped neck produces controlled fragmentation
- Rear section rivets to ensure a reliable exit wound
- Little damage to the meat

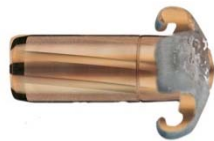



H-MANTEL HM

For maximum effect

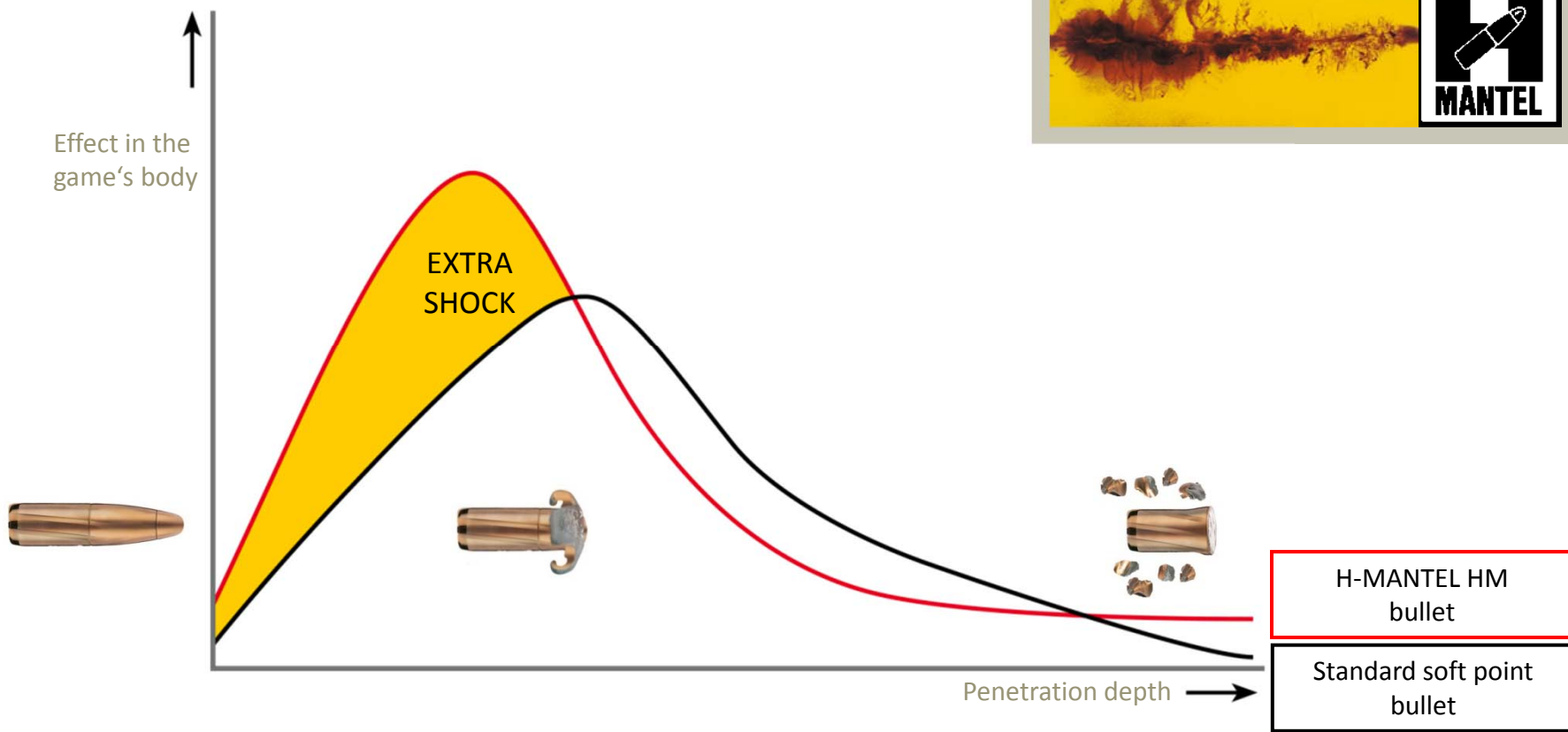
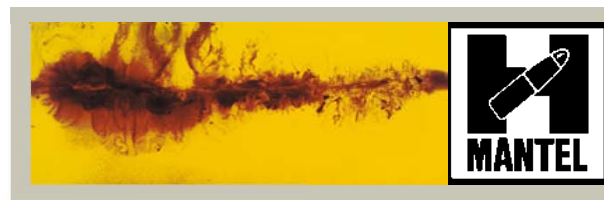



KS CONE POINT BULLET

For maximum accuracy

53

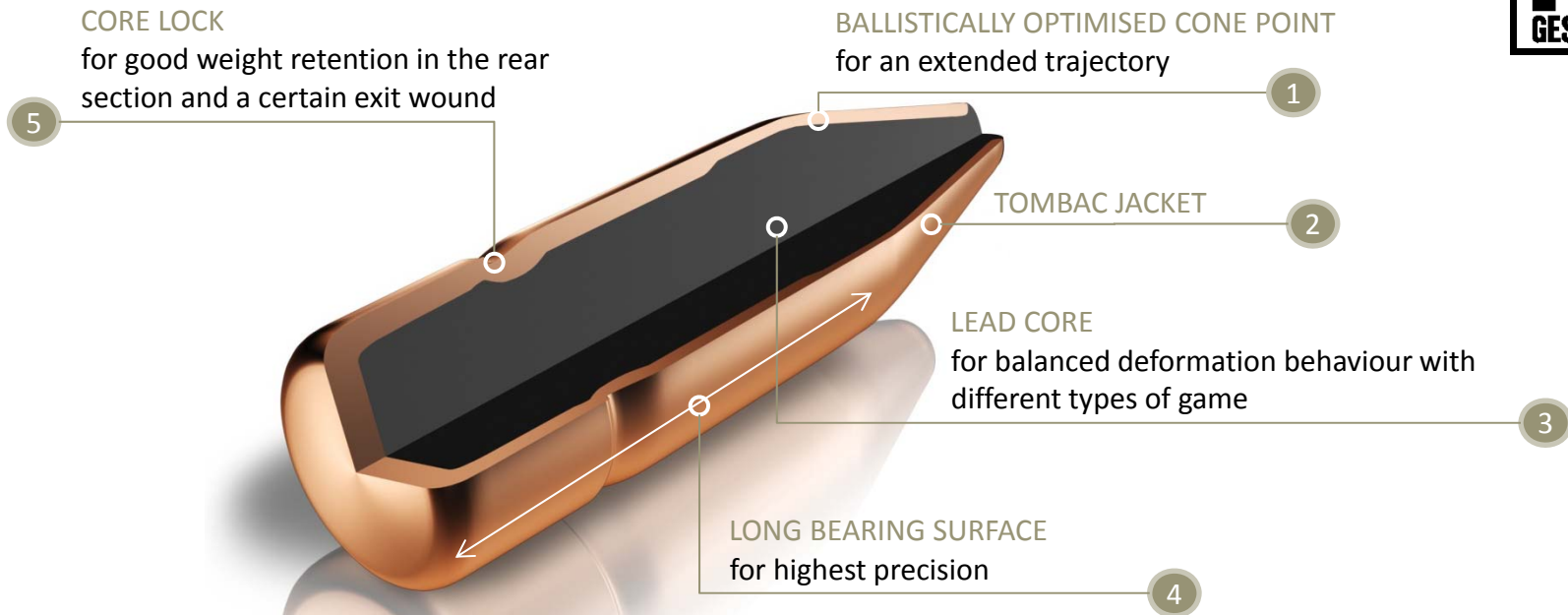



CONE POINT KS

For maximum accuracy

- Extraordinary accuracy thanks to the long bearing surface
- The rear core lock stops deformation and ensures a compact rear section, giving a high probability of an exit wound
- Few fragments remain in the body of the game





KEGELSPITZ

For maximum accuracy

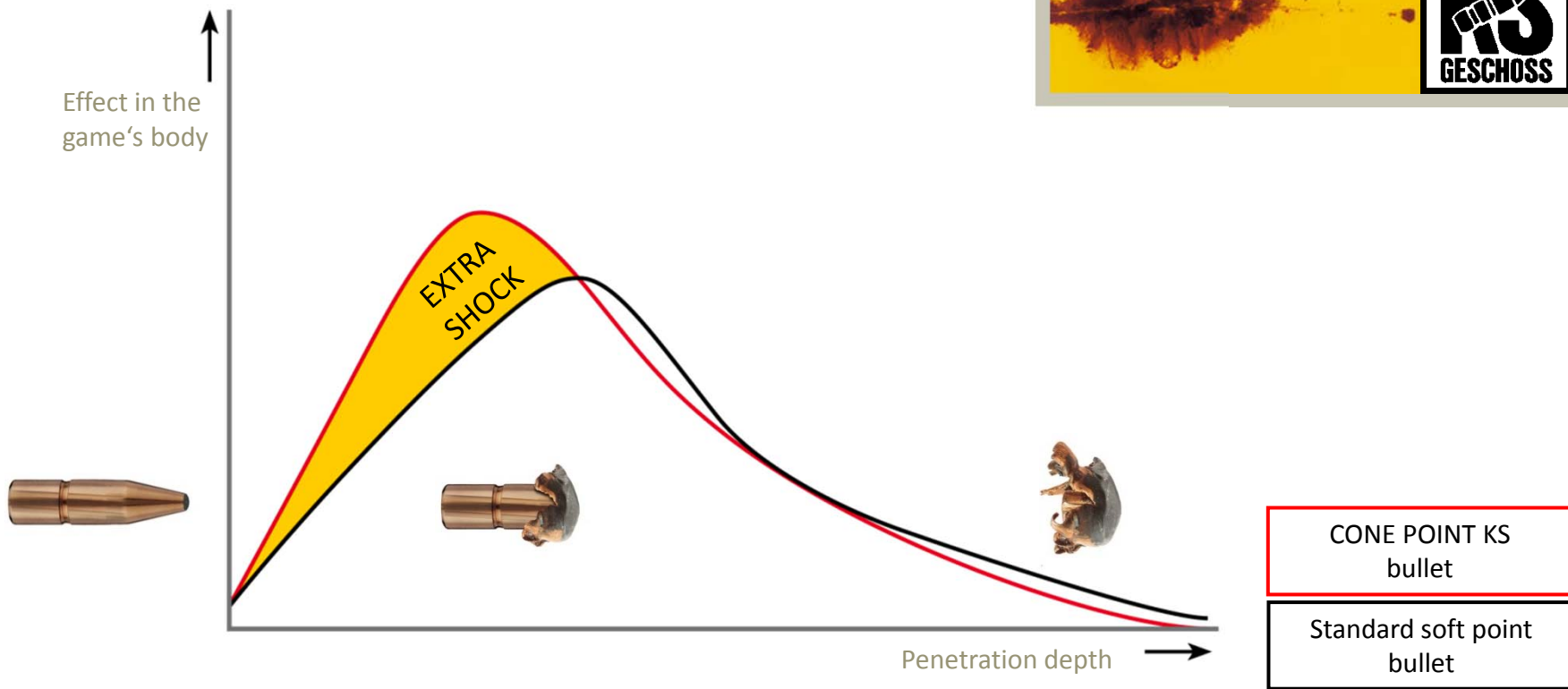



SPEED TIP

For maximum effectiveness even at long range

56

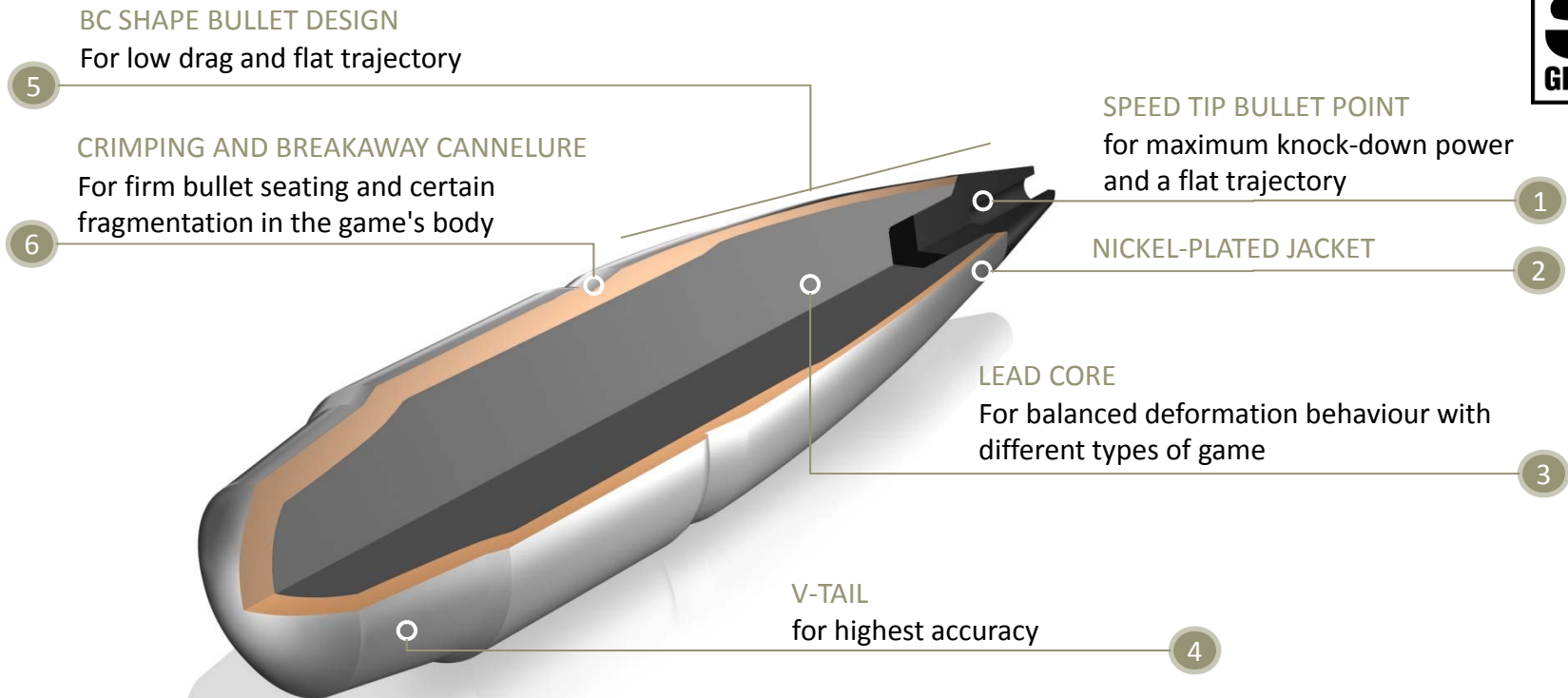



SPEED TIP

For maximum effectiveness even at long range

- Extreme knockdown power, even at long range
- Extremely flat trajectory thanks to an effective new bullet profile
- Convincing accuracy

57





SPEED TIP

For maximum effectiveness even at long range

58

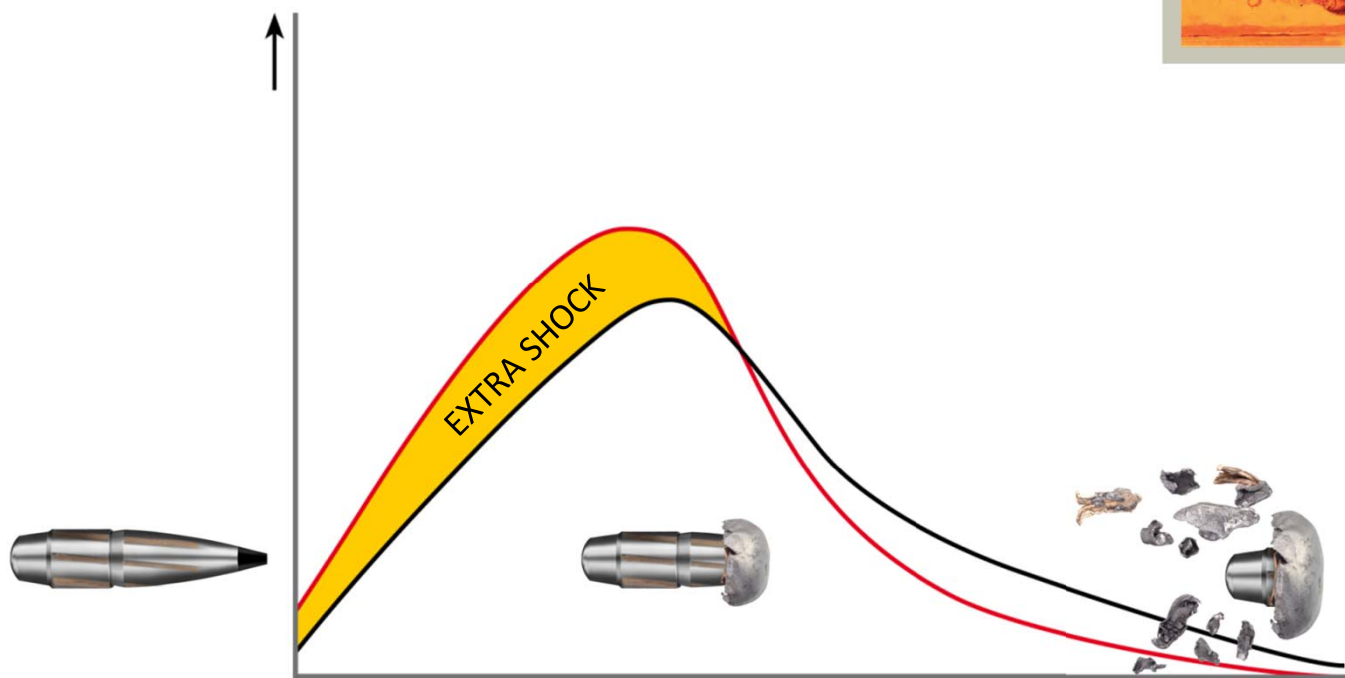

SPEED TIP
bullet

Standard
soft point bullet



COMPARISON OF RWS SPECIAL BULLETS sorted by pertinent hunting characteristics

59

ACCURACY

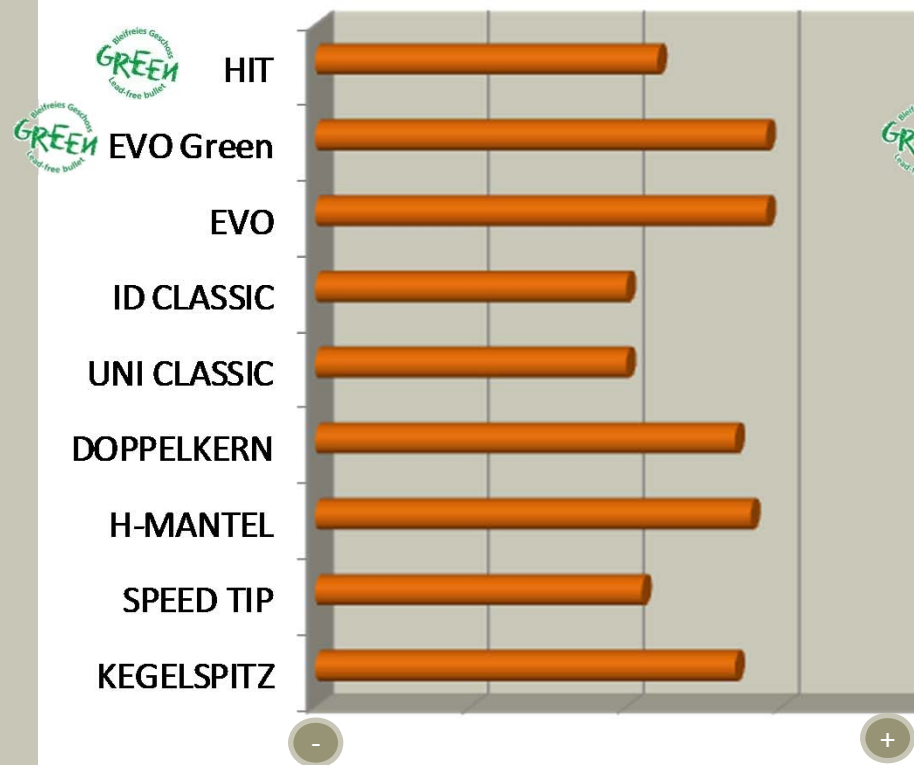

VELOCITY

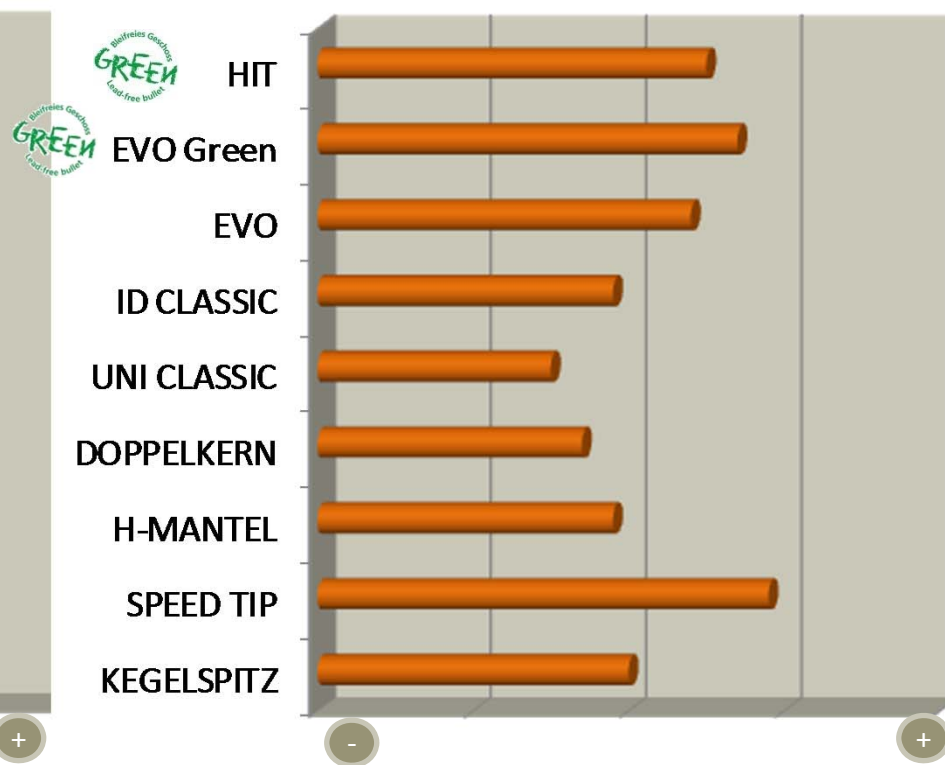



COMPARISON OF RWS SPECIAL BULLETS sorted by pertinent hunting characteristics

60

INITIAL SHOCK

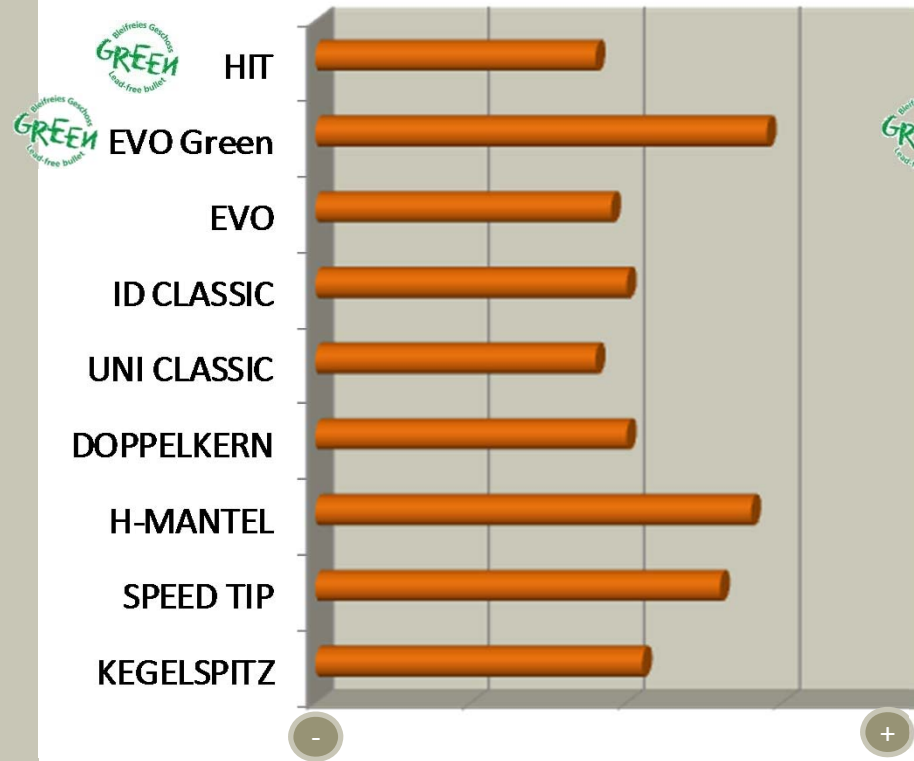

VENISON PRESERVATION

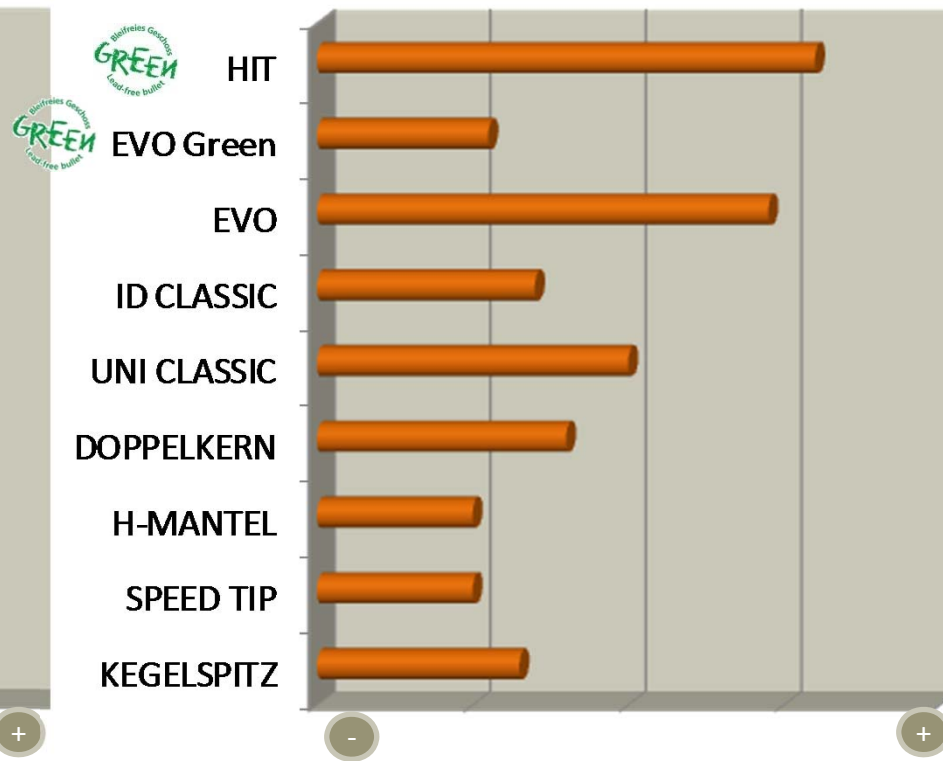



COMPARISON OF RWS SPECIAL BULLETS sorted by pertinent hunting characteristics

LONG-RANGE CAPABILITY

SUITABILITY FOR DRIVEN GAME

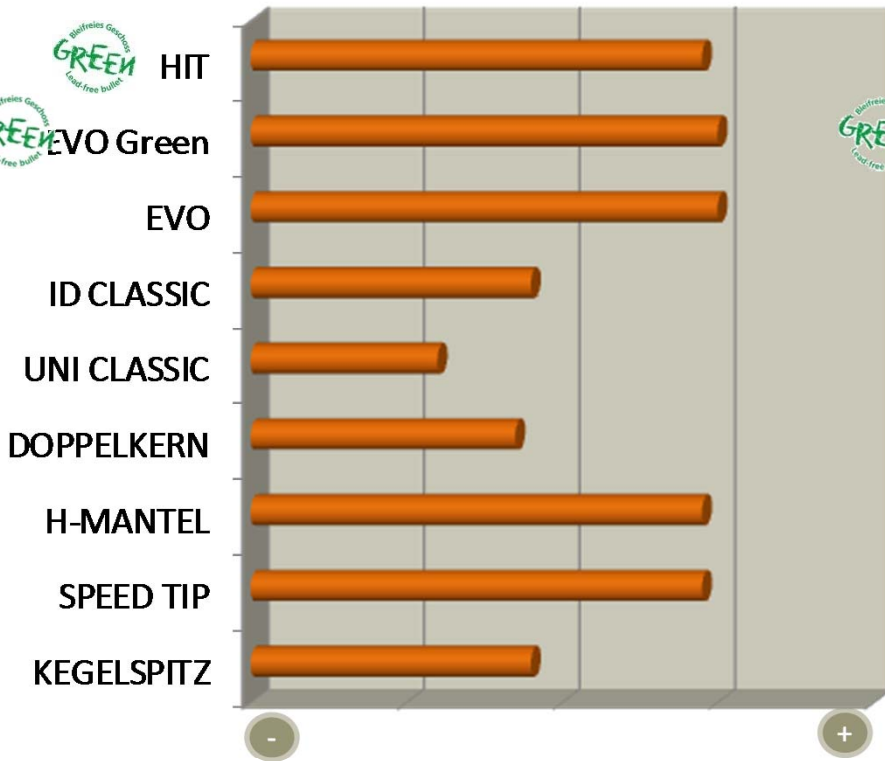



COMPARISON OF RWS SPECIAL BULLETS sorted by pertinent hunting characteristics

62

SUITABILITY FOR HEAVY GAME

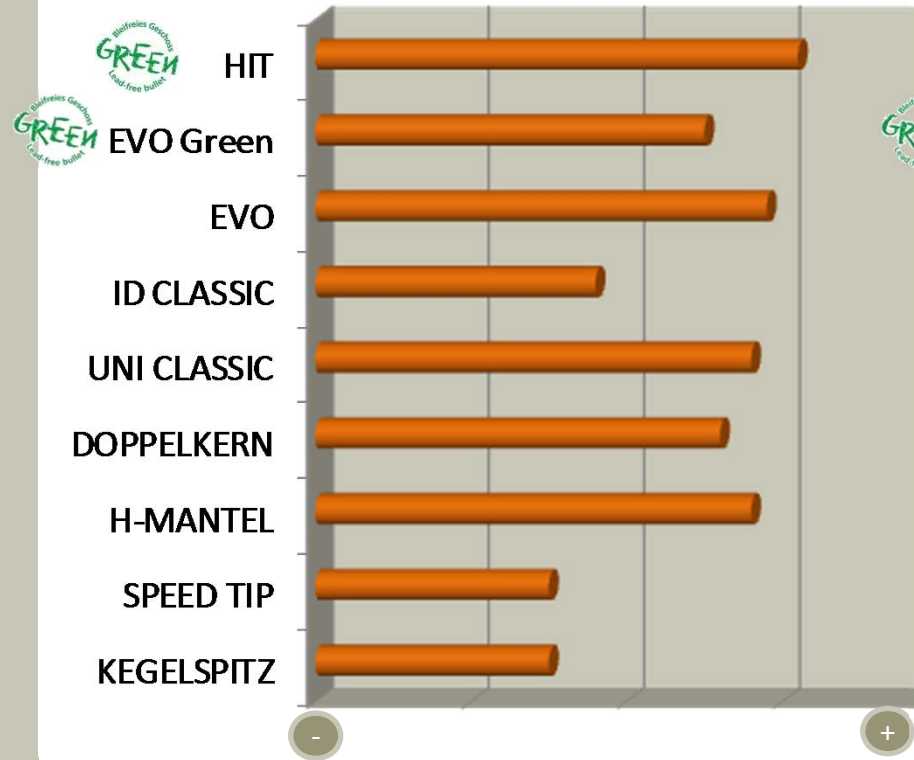

SUITABILITY FOR LIGHT GAME





WHICH CARTRIDGE FOR WHICH GAME?

The RWS App can tell you!

63

The image shows three smartphones displaying the RWS app interface. The leftmost phone shows the 'Patronen Typ' (Cartridge Type) screen with options for 'Schrotpatronen' (Shotgun Cartridges) and 'Büchsenpatronen' (Rifle Cartridges). The middle phone shows the 'Übersicht' (Overview) screen with a list of cartridges including 'Rotwell Jagd braun Streu 12/70 3,2 mm', 'Rotwell Fasan FF 12/67,5 2,4 mm 28g', 'Rotwell Fasan FF 16/67,5 2,0 mm', 'Rotwell Fasan FF 16/67,5 2,4 mm', and 'Rotwell Fasan FF 20/67,5 2,0 mm'. The rightmost phone shows a detailed view of a cartridge with the title 'Übersicht' and technical specifications like '8 WIN BIONIC BLACK 10,0G', '8 WIN ID Classic 9,7G', '8 WIN KS 9,7G', '57 ID Classic 10,5G', and '57 R DK 10,0G'. To the right of the phones are three rifle cartridges: a large gold-tipped cartridge, a smaller gold-tipped cartridge, and a green-tipped cartridge with a detailed label.

FREE Download
Erhältlich im App Store
ANDROID APP ON Google play



THE HUNT IS SELDOM PREDICTABLE.
We develop products for every situation.

64

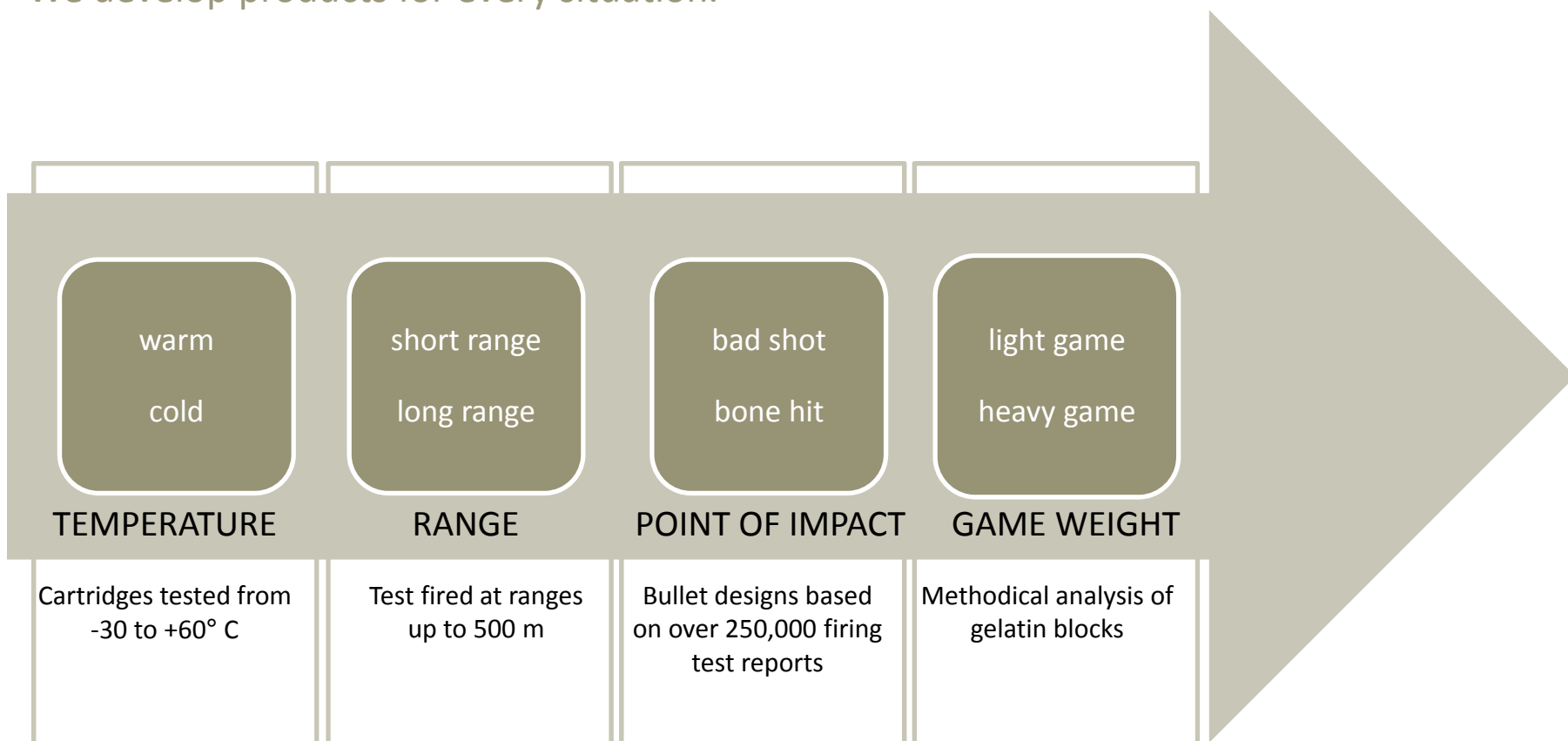



SPECIAL SERIES

RWS Special Edition, Silver Selection, Target Elite and Cineshot





SILVER SELECTION

Technically and aesthetically unique



Silver Selection



NICKEL FINISHED CASE
For easier chambering and fast reloading

1



FLASH CONTROL
For reduced muzzle flash to keep the hunting situation in view

2



HIGH PERFORMANCE LOAD
For power reserves in extreme situations

3



SUPER CLEAN
For maximum functional reliability without pollution

4



UNI PROFESSIONAL
For accuracy, flat trajectory and high effectiveness

5



EVO EVOLUTION
For accuracy, penetration and flexibility

6



SILVER SELECTION

Technically and aesthetically unique

67



„On my expeditions to Greenland I always have my rifle and ammunition with me. In the event of an attack by a polar bear, I want to be prepared.[...] So the Silver Selection, developed for extreme conditions and with an unparalleled reliability, has become my life insurance.“

Kasper Johansen
(Researcher with the Danish National Environmental Research Institute)



SPECIAL EDITION

The perfect gift with a personal touch

- 30 rifle cartridges with gold-plated H-Mantel HM bullets, manually loaded into black ruthenium-plated cases, are presented in a deluxe wooden box
- Personalised with your name or inscription
- Ballistically optimised by using selected components and manual loading techniques





CINESHOT

The first cartridge made especially for shooting cinema use.

- **FOR HEALTHY TRAINING:**
No lead contamination of the shooter's environment thanks to the lead-free SuperClean® primer technology and a partially encapsulated bullet
- **FOR INTENSIVE TRAINING WITHOUT OVERHEATING AND INTENSIVE CLEANING:**
A special surface coating of the bullet minimises friction between the bullet and the bore.





TARGET ELITE AND TARGET ELITE PLUS

Ultimate match grade cartridges

- For competitive disciplines up to 600 m with TARGET ELITE and up to 1200 m with TARGET ELITE PLUS
- Competition-grade accuracy



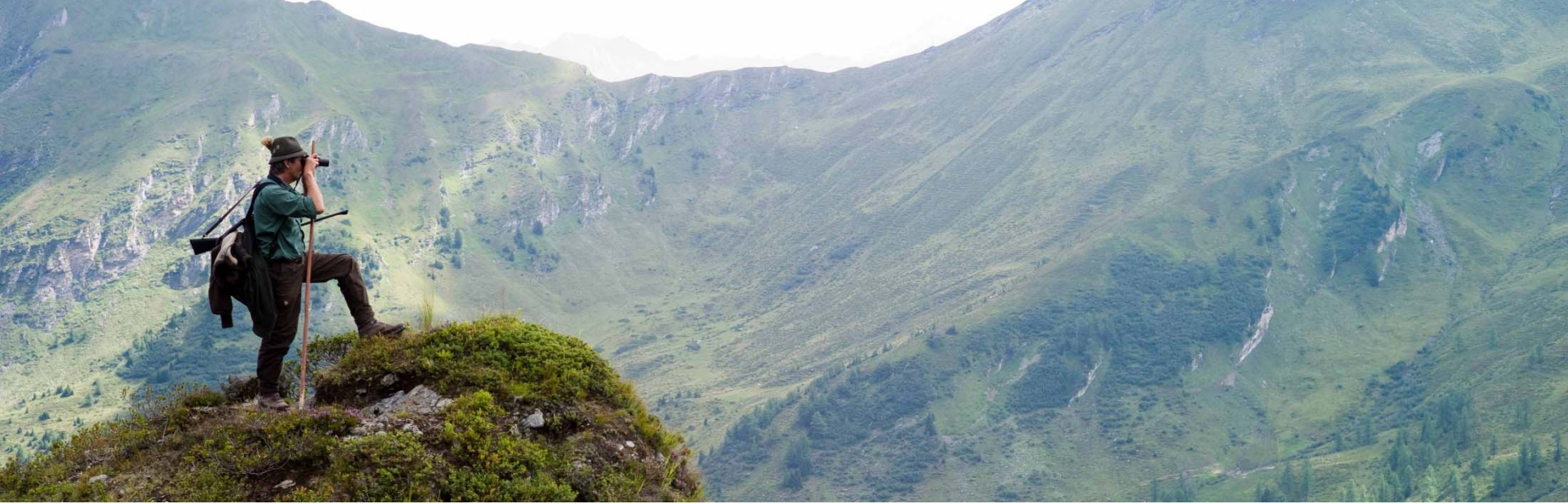

OUTLOOK AND SUMMARY

the evolution continues





THE EVOLUTION CONTINUES

RWS experts are already working on tomorrow's innovations.

72

Developmental time line of the H-Mantel HM bullet since its introduction in 1934.





EXCITEMENT,

When innovation enhances the hunting experience.

- More than 100 patents in the field of projectile and cartridge case development
- More than 50 patents in the field of powders and primers

RWS expands hunting opportunities today and will surpass current technology in the future.

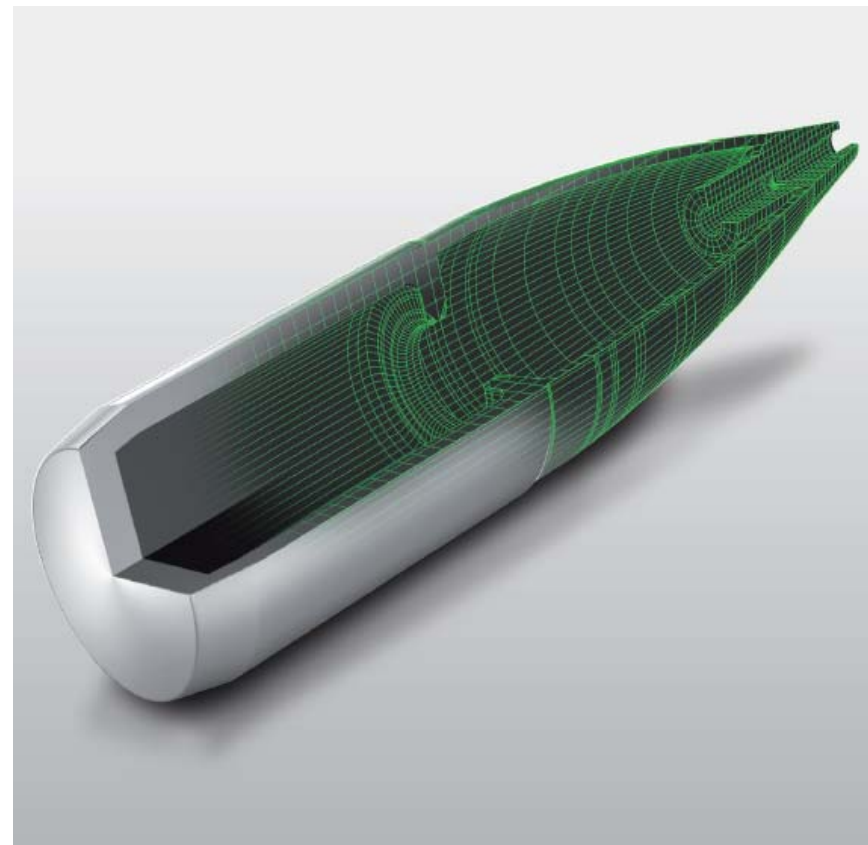



DOES IT REALLY HAVE TO BE RWS?

Yes, so that the joy of hunting doesn't fall by the wayside!

- RWS is always reliable!
- RWS is always accurate!
- RWS works at long range!
- RWS works even with a poorly placed shot!
- RWS for maximum safety!

This is what makes RWS unique.





THE GAME DESERVES YOUR BEST SHOT!

RWS – The ammunition counts.

75





THANK YOU FOR YOUR ATTENTION!